

Assortimentsoverzicht

2011-01

**OK jassen
Beschermende kleding
Standaard pakketten
OK-lakens
Accessoires**

1	OK-jassen	5
1.1	SMS OK-jassen.....	5
1.2	Spunlace OK jassen.....	6
1.3	Prestico® OK jassen.....	7
1.4	Bezoekers jassen.....	8
1.5	TUR Jassen.....	9
1.6	Chemo Cytostatica jassen.....	10
1.7	Warm-up jacket.....	11
1.8	Omloop pak.....	12
1.9	OK mutsen.....	13
1.10	Schoen overtrekken.....	15
2	Algemene Chirurgie	16
2.1	Universeel pakket.....	16
2.2	Universeel kinderpakket SMS.....	17
2.3	Universeel Pakket Prestico®.....	18
2.4	Universeel U-Bar pakket 3-laags.....	19
2.5	Splitlaken pakket Prestico®.....	20
2.6	Bovenlakens.....	21
2.7	Onderlakens.....	24
2.8	Zijlakens.....	25
2.9	Splitlakens.....	26
2.9.1	Splitlaken 300x200cm, split 6x94cm.....	26
2.9.2	Splitlaken 180x240cm, split 10x50cm.....	27
2.9.3	Splitlaken 300x200cm, split 10x100cm.....	28
2.9.4	Splitlaken 300x200cm, split 15x100cm.....	29
2.9.5	Splitlaken 320x200cm, split 15x140cm.....	30
2.9.6	Splitlaken 260x200cm, split 20x100cm.....	31
2.9.7	Splitlaken 300x200cm, split 30x75cm.....	32
2.9.8	Splitlaken 185x140cm, split 15x55cm.....	33
2.10	Laparotomie lakens.....	34
2.10.1	Laparotomie laken 285 x 180/250cm, Prestico®.....	34
2.10.2	Laparotomie laken 305x200/252 cm, Prestico®.....	35
2.10.3	Laparotomie laken 355x190/300 cm.....	36
2.11	Algemene lakens.....	37
2.11.1	Instrumentenvelden.....	37
2.11.2	Overzet-tafelsloop.....	38
2.11.3	Tissue Laminaat lakens.....	39
2.11.4	SMS lakens.....	40
2.11.5	Prestico® lakens.....	41
2.11.6	2-laags lakens.....	42
2.11.7	Lakens met tape SMS.....	43
2.11.8	Lakens met tape 2-laags.....	44
2.11.9	Lakens met tape 3-laags.....	45
2.12	Lakens met Venster.....	46
2.12.1	Gatlakens Tissue Laminaat.....	46
2.13	Lakens met Venster en tape.....	47
2.13.1	Gatlakens 2-laags.....	47
2.13.2	Gatlakens 3-laags.....	48
2.13.3	Gatlakens SMS.....	49
2.13.4	Gatlakens Prestico®.....	50
2.14	Variabel Venster lakens met tape.....	51
2.14.1	Variabel gatlaken 35x40cm 2-laags.....	51
2.14.2	Variabel gatlaken 75x120cm 2-laags.....	52
2.14.3	Variabel gatlaken 100x170cm SMS.....	53
2.15	Stuitlakens.....	54

3	Orthopedie	55
3.1	Orthopedie splitlaken pakket SMS.....	55
3.2	Orthopedie splitlaken pakket Prestico®.....	56
3.3	Extremiteiten (hand) pakket SMS.....	57
3.4	Extremiteiten (voet/been) pakket SMS.....	58
3.5	Arthroscopie pakket SMS.....	59
3.6	Extremiteiten lakens.....	60
3.6.1	Extremiteitenlakens met Elastisch Venster, SMS.....	60
3.6.2	Extremiteiten lakens met Elastisch Venster, Prestico®.....	61
3.6.3	Extremiteitenlakens met Elastisch Venster, 3-laags.....	62
3.6.4	Extremiteitenlakens hand-voet met Elastisch Venster, 3-laags.....	63
3.6.5	Bilateraal extremiteitenlakens met twee elastische vensters SMS.....	64
3.6.6	Bilateraal extremiteiten lakens met twee elastische vensters Prestico®.....	65
3.6.7	Extremiteiten lakens met Elastisch Venster en Armsteun bedekkingen Prestico®.....	66
3.6.8	Extremiteiten lakens met Elastisch Venster en Armsteun bedekkingen 3-laags.....	67
3.6.9	Arthroscopie lakens met vloeistofopvangzak 2-laags.....	68
3.6.10	Arthroscopie lakens met vloeistofopvangzak SMS.....	69
3.6.11	Schouderlakens.....	70
3.6.12	Beach chair lakens SMS.....	71
3.6.13	Beach chair lakens 3-laags.....	72
3.6.14	Heuplakens met vloeistofopvangzak en Armsteun bedekkingen.....	73
3.6.15	Handlakens SMS.....	74
3.6.16	Handlakens Prestico®.....	75
3.6.17	Handlakens 3-laags.....	76
3.7	Vertical isolatie lakens.....	77
4	Gynaecologie, verloskunde en urologie	78
4.1	Omega pakket SMS.....	78
4.2	Gynaecologie pakket I SMS.....	79
4.3	Gynaecologie II pakket SMS.....	80
4.4	C-Sectio pack SMS.....	81
4.5	Gynaecologie-Urologie Lakens.....	82
4.5.1	Gyn-Uro lakens, 345 x 75/265/180 cm met beenhoezen SMS.....	82
4.5.2	Gyn-Uro lakens, 345 x 75/265/180 cm met beenhoezen Prestico®.....	83
4.5.3	Gyn-Uro lakens, 335 x 75/145/265 cm met beenhoezen 3-laags.....	84
4.5.4	Gyn-Uro lakens, 275 x 75/265 cm met beenhoezen.....	85
4.5.5	Gyn-Uro lakens, 115 x 60 cm.....	86
4.6	Laparotomie-Gynaecologie lakens.....	87
4.6.1	Lap-Gyn lakens, 225 x 255/180/225 cm met arm board covers en beenhoezen.....	87
4.6.2	Lap-Gyn-HIPEC lakens, 291 x 275/210/260 cm met armsteunbedekking an beenhoezen.....	88
4.7	C-Sectio lakens.....	89
4.7.1	C-Sectio lakens met vloeistofopvangzak, volledig Incisie film SMS.....	89
4.7.2	C-Section lakens met vloeistofopvangzak, Gat Incisie film en beenhoezen SMS.....	90
4.7.3	C-Section lakens met vloeistofopvangzak, volledig Incisie film Prestico®.....	91
4.7.4	C-Section lakens met vloeistofopvangzak, Gat Incisie film Prestico®.....	92
4.7.5	C-Section lakens met vloeistofopvangzak, volledig Incisie film 3-laags.....	93
4.7.6	C-Section lakens met vloeistofopvangzak, Gat Incisie film 3-laags.....	94
4.8	T.U.R. Lakens.....	95
4.8.1	T.U.R. lakens.....	95
4.8.2	T.U.R. lakens met Vloeistofopvangzak.....	96
4.9	Nephroscopie lakens.....	97
5	Oogheelkunde	98
5.1	Ooglakens, ovaal Venster, vloeistofopvangzak.....	98
5.2	Ooglakens, ovaal Venster, vloeistofopvangzak, Incisie tape.....	99
5.3	Ooglakens, vierkant venster en vloeistofopvangzak.....	100
5.4	Oog lakens, vierkant Venster, vloeistofopvangzak en Incisie film.....	101
5.5	Ooglakens, vierkant Venster en vloeistofopvangzak.....	102
6	KNO (Keel-Neus-Oor) en Neurologie	103
6.1	Thyroid pack SMS.....	103
6.2	Hoofdlakens.....	104
6.3	Hoofdlakens 2-delen.....	105
6.4	Gezichtslakens.....	106
6.5	Mondheelkunde lakens.....	107
6.6	Craniotomie lakens.....	109
7	Cardiovasculair	110
7.1	Cardiovasculair lakens.....	110

8	Angiografie	111
8.1	Femoraal Angio lakens	111
8.1.1	Femoraal Angio laken, volledig transparant rechts	111
8.1.2	Femoraal Angio laken Ultra absorberend, volledig Transparant rechts en links	112
8.1.3	Femoraal Angio laken Ultra absorberend, volledig Transparant rechts en links XL	113
8.1.4	Femoraal Angio laken Ultra absorberend, volledig Transparant rechts en links XW	114
8.1.5	Femoraal Angio laken, Ultra Absorberend, volledig Transparant 3-sides	115
8.1.6	Femoraal Paediatric Angiography laken	116
8.2	Femoraal Radial Angio lakens	117
8.2.1	Femoraal Radial Angiografie laken, standaard	117
8.2.2	Femoraal Radial Angiography laken, XL	118
9	Pacemaker lakens	119
9.1	Pacemaker laken met Venster	119
9.2	Pacemaker laken met Venster en Incisie tape	120
9.3	Pacemaker tunnel laken	121
10	Accessoires	122
10.1	Tape strip	122
10.2	Mouwtje	122
10.3	Armsteun hoes en stoelhoes	123
10.4	Stockinettes	124
10.5	Stockinettes eco verpakking	125
10.6	Roll Stockinettes	126
10.7	Beenhoezen	127
10.8	Diathermie zakken	128
10.9	Handdoekje	129
10.10	Baby Handdoekje	129
10.11	Perineal laken	130
11	Code index component	131
12	Code index component beschermende kleding niet steriel	133
13	Product code index ordernummers steriel	134

1 OK-jassen

1.1 SMS OK-jassen

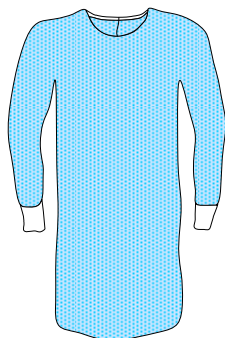

● SMS

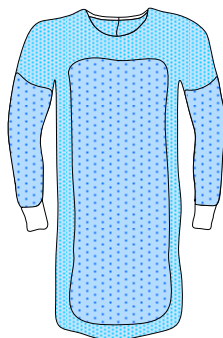

● SMS ● SMS PRF

Afmetingen	Type	Component nummer	Bestel nummer	Aantal per doos	Bestel nummer steriel	Aantal per doos steriel
			Standaard verpakking		Eco verpakking	
L	Basic	1306748	2540540	15	11011EG	42
XL	Basic	1306749	2541940	15	11013EG	34
XXL	Basic	1306750	2540530	10	11014EG	34
L XLong	Basic	1302219	2542530	14	11015EG	40
XL XLong	Basic	1302220	2542540	14	11016EG	30
XXL XLong	Basic	1302221	2542550	9	11017EG	30
L	Polyethyleen Versterkt	1302502	2543010		11140EG	
XL	Polyethyleen Versterkt	1306745	2540570	12	11024EG	30
XXL	Polyethyleen Versterkt	1306746	2540600	8	11026EG	24
L XLong	Polyethyleen Versterkt	1302503	2543020		11141EG	
XL XLong	Polyethyleen Versterkt	1302225	2542710	11	11027EG	28
XXL XLong	Polyethyleen Versterkt	1302226	2542720	7	11028EG	26

Standaard jas: voor relatief droge procedures.

Polyethyleen versterkt: voor relatief natte procedures met veel vocht.

Lengtematen SMS: L is 122 cm, XL is 134 cm, XXL is 145 cm

Lengtematen SMS Extra Long: L is 132 cm, XL is 144 cm, XXL is 155 cm

Voorzien van elastische manchetten.

Voorzien van halssluiting met klittenband.

Steriele jas wordt verpakt met handdoekje in een papierwikkeltje in een peelable zak.

Jassen zijn latexvrij

Voldoet aan de EN 13795 norm.

1.2 Spunlace OK jassen

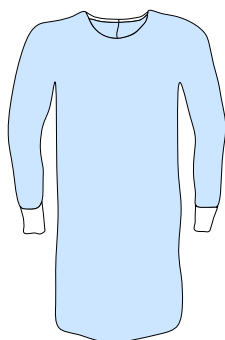

● Spunlace



● Spunlace ● Spunlace FRF

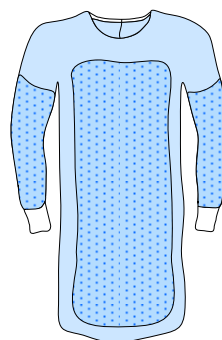

● Spunlace ● Spunlace PRF

Afmetingen	Type	Component nummer	Bestel nummer steriel	Aantal per doos	Bestel nummer steriel	Aantal per doos
					Standaard verpakking	Eco verpakking
L	Basic	1307070	2540610	15	11073EG	32
XL	Basic	1307071	2540620	12	11074EG	34
XXL	Basic	1307072	2540630	12	11075EG	34
L XLong	Basic	1301873	2542080	10	11076EG	40
XL XLong	Basic	1301874	2542090	10	11077EG	34
XXL XLong	Basic	1301875	2542100	8	11078EG	34
L	Materiaal Versterkt	1307076	2540650	12	11079EG	30
XL	Materiaal Versterkt	1307077	2541950	12	11080EG	27
XXL	Materiaal Versterkt	1307078	2540670	12	11082EG	22
L XLong	Materiaal Versterkt	1301876	2542110	10	11083EG	36
XL XLong	Materiaal Versterkt	1301829	2542120	12	11084EG	33
XXL XLong	Materiaal Versterkt	1301830	2542130	8	11085EG	28
L	Polyethyleen Versterkt	1307082	2540680	12	11086EG	33
XL	Polyethyleen Versterkt	1307083	2540690	12	11087EG	36
XXL	Polyethyleen Versterkt	1307084	2540700	10	11088EG	26
L XLong	Polyethyleen Versterkt	1301877	2542140	8	11089EG	32
XL XLong	Polyethyleen Versterkt	1301878	2542150	10	11090EG	34
XXL XLong	Polyethyleen Versterkt	1301879	2542160	8	11091EG	28

Standaard jas: voor relatief droge procedures.

Materiaal versterkt: voor relatief natte procedures.

Polyethyleen versterkt: voor relatief natte procedures met veel vocht.

Lengtematen Spunlace: L is 122 cm, XL is 133 cm, XXL is 152 cm

Lengtematen Spunlace: Extra Long: L is 135 cm, XL is 149 cm, XXL is 165 cm

Voorzien van elastische manchetten.

Voorzien van halssluiting met klittenband.

Steriele jas wordt verpakt met handdoekje in een papierwikkel in een peelable zak.

Jassen zijn latexvrij

Voldoet aan de EN 13795 norm.

1.3 Prestico® Ok jassen

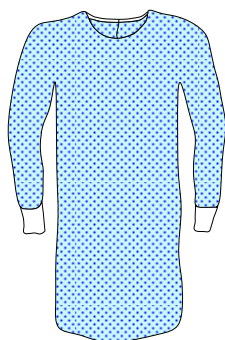

 Prestico®

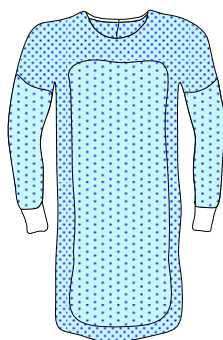

 Prestico®  Prestico® FRF

Afmetingen	Type	Component nummer	Bestel nummer steriel	Aantal per doos	Bestel nummer steriel	Aantal per doos
				Standaard verpakking	Eco verpakking	
L	Basic	1307335	2542560	15	11100EG	
XL	Basic	1307336	2542570	12	11101EG	
XXL	Basic	1307337	2542580	12	11102EG	
L XLong	Basic	1307338	2542590	15	11103EG	
XL XLong	Basic	1307339	2542600	10	11104EG	
XXL XLong	Basic	1307340	2542610	8	11105EG	
L	Materiaal Versterkt	1307341	2542650	12	11106EG	
XL	Materiaal Versterkt	1307342	2542660	12	11107EG	
XXL	Materiaal Versterkt	1307343	2542670	12	11108EG	
L XLong	Materiaal Versterkt	1307344	2542680	10	11109EG	
XL XLong	Materiaal Versterkt	1307345	2542690	12	11110EG	
XXL XLong	Materiaal Versterkt	1307346	2542700	8	11111EG	

Standaard jas: voor relatief droge procedures.

Materiaal versterkt: voor relatief natte procedures.

Lengtematen Prestico®: L is 122 cm, XL is 133 cm, XXL is 152 cm

Lengtematen Prestico®: Extra Long: L is 135 cm, XL is 149 cm, XXL is 165 cm

Voorzien van elastische manchetten.

Voorzien van halssluiting met klittenband.

Steriele jas wordt verpakt met handdoekje in een papierwikkeltje in een peelable zak.

Jassen zijn latexvrij

Voldoet aan de EN 13795 norm.

1.4 Bezoekers jassen

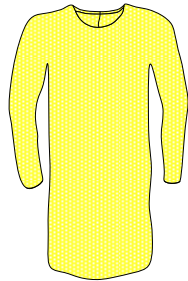

Zonder manchet

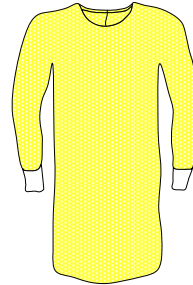

Met manchet

Manchet	Maat	Materiaal	Component nummer	Ordernummer non steriel	Aantal per doos
Nee	XL	PSB 28 gr.	1301690	06541	100
Ja	XL	PSB 28 gr.	1301691	06542	100

1.5 TUR Jassen

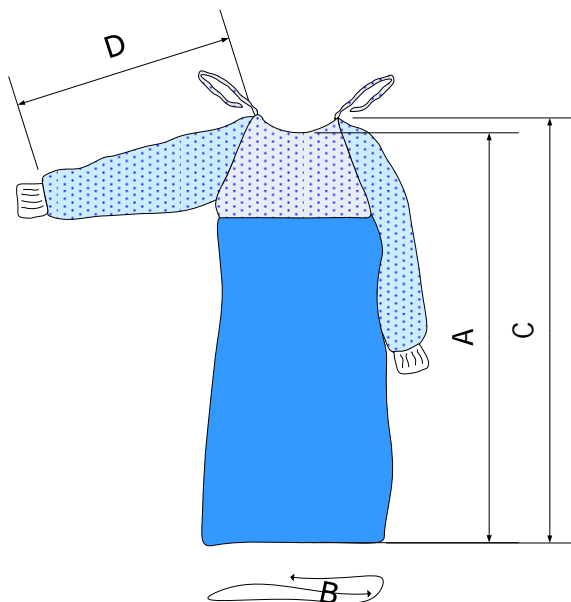

 Suprel® 51
  Suprel® 100
  PE Film 50 micron

Af-metingen	Materiaal	Component nummer	Bestelnummer steriel	Aantal per doos
L	Suprel®	1301742	2542340	12
XL	Suprel®	1301741	2542350	12

Large A=132cm, B=148cm, C=144cm, D=75cm (+/- 3cm)

Extra Large A=144cm, B=146cm, C=154cm, D=91cm (+/- 3cm)

Suprel® 51 (waterkolom 51cm), Suprel® 100 (waterkolom 100cm)

Voorpand volledig ondoorlaatbaar als bescherming tegen doorbraak.

Geschikt voor zittende procedure.

Voorzien van elastische manchetten.

Steriele jas wordt verpakt met twee handdoekjes in een papierwikkel in een peelable zak.

Jassen zijn latexvrij

Voldoet aan de EN 13795 norm.

Large A=132cm, B=148cm, C=144cm, D=75cm (+/- 3cm)

1.6 Chemo Cytostatica jassen

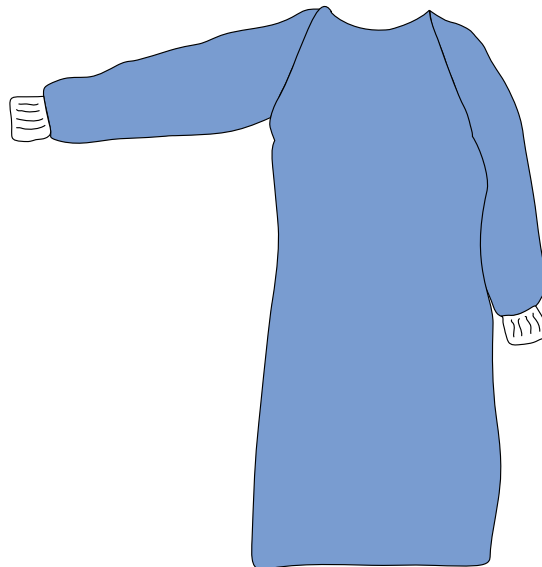

Maat	Materiaal	Component nummer	Order nummer sterile	Aantal per doos
XL	SMS/PE	1302642	2544070	
XL Extra Long	SMS/PE	1302376	2544080	

Lengte, XL is 132 cm, XL Extra long is 143 cm (\pm 1,5cm)

Voldoet aan; ISO 6529:2001; Bescherming tegen chemische vloeistof (Cytostatica)

Voldoet aan; EN 13795 norm

Steriele jas wordt verpakt met twee handdoekjes in een papierwikkelpak in een peelable zak.

Jassen zijn latexvrij

1.7 Warm-up jacket

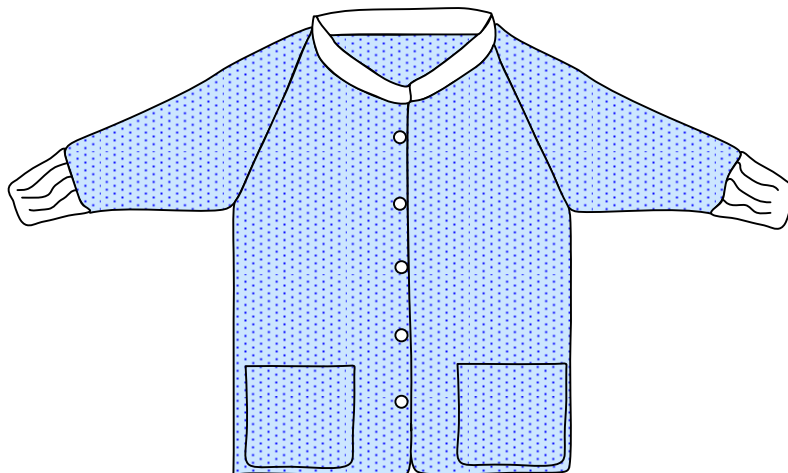

Omschrijving	Maat	Component nummer	Ordernummer niet steriel	Per doos
Warm-up jacket ¾ sleeve length	M	1307297	104200AA	60
Warm-up jacket ¾ sleeve length	L	1307298	104201AA	60

1.8 Omloop pak

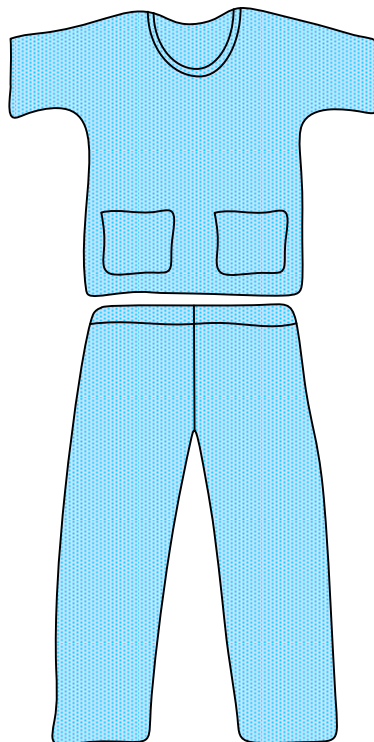

Omschrijving	Component nummer	Ordernummer niet steriel	Per doos
Omlooppak 45 Grams SMS (large)	1301956	06580	50

1.9 OK mutsen

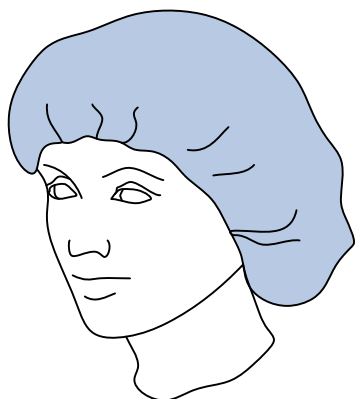

Bouffant standaard



Bouffant large

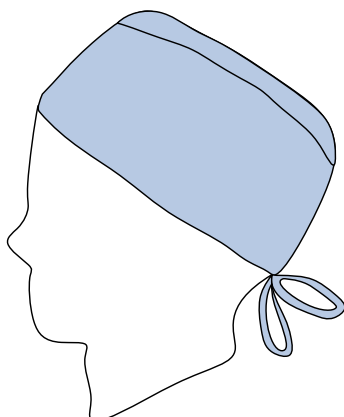

OK muts met strik

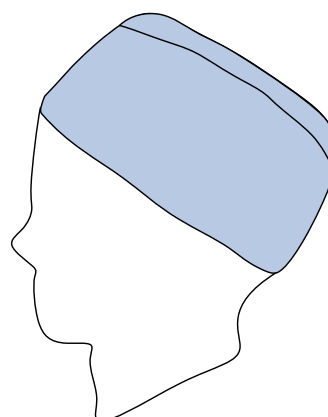

OK muts met elastiek

Omschrijving	Component nummer	Ordernummer niet steriel	Per doos
Bouffant 21 inch (54 cm) standaard	1301914	06581	500
Bouffant 24 inch (61 cm) large	1301915	06582	500
OK muts met strik	1302081	52557	500
OK muts met elastiek	1302083	52558	500

100 stuks in een dispenser box, 5 dispenser boxen in een doos

1.8 OK mutsen (vervolg)

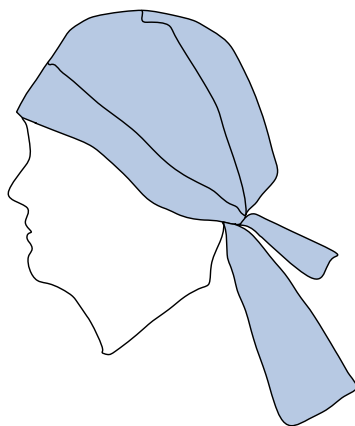

OK muts met brede strik

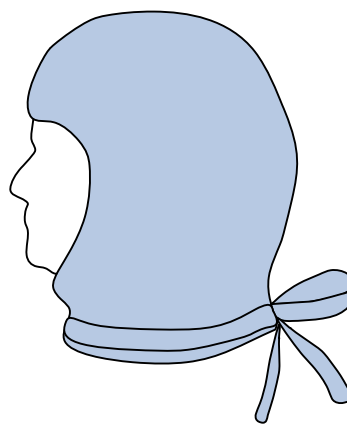

Chirurgische muts met striklint

Omschrijving	Component nummer	Ordernummer niet steriel	Per doos
OK muts met brede strik	1302114	06583	500
Chirurgische muts met striklint	1302085	10155	500

100 stuks in een dispenser box, 5 dispenser boxen in een doos

1.10 Schoen overtrekken

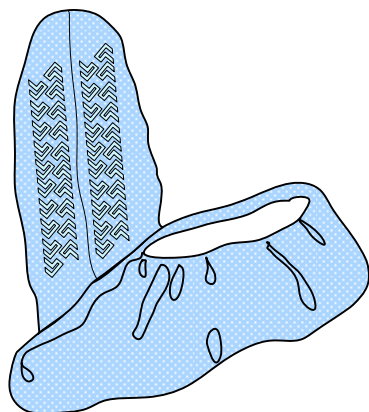

Anti-slip schoenhoes

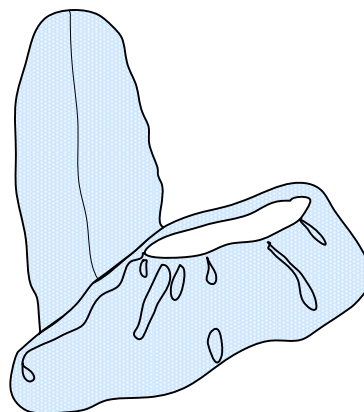

Standaard schoenhoes

Description	Component nummer	Ordernummer niet steriel	Per doos
Anti-slip schoenhoes	1301673	06536	300
Standaard schoenhoes	1301676	06537	300

100 stuks in een dispenser box, 3 dispenser boxen in een doos

2 Algemene Chirurgie

2.1 Universeel pakket

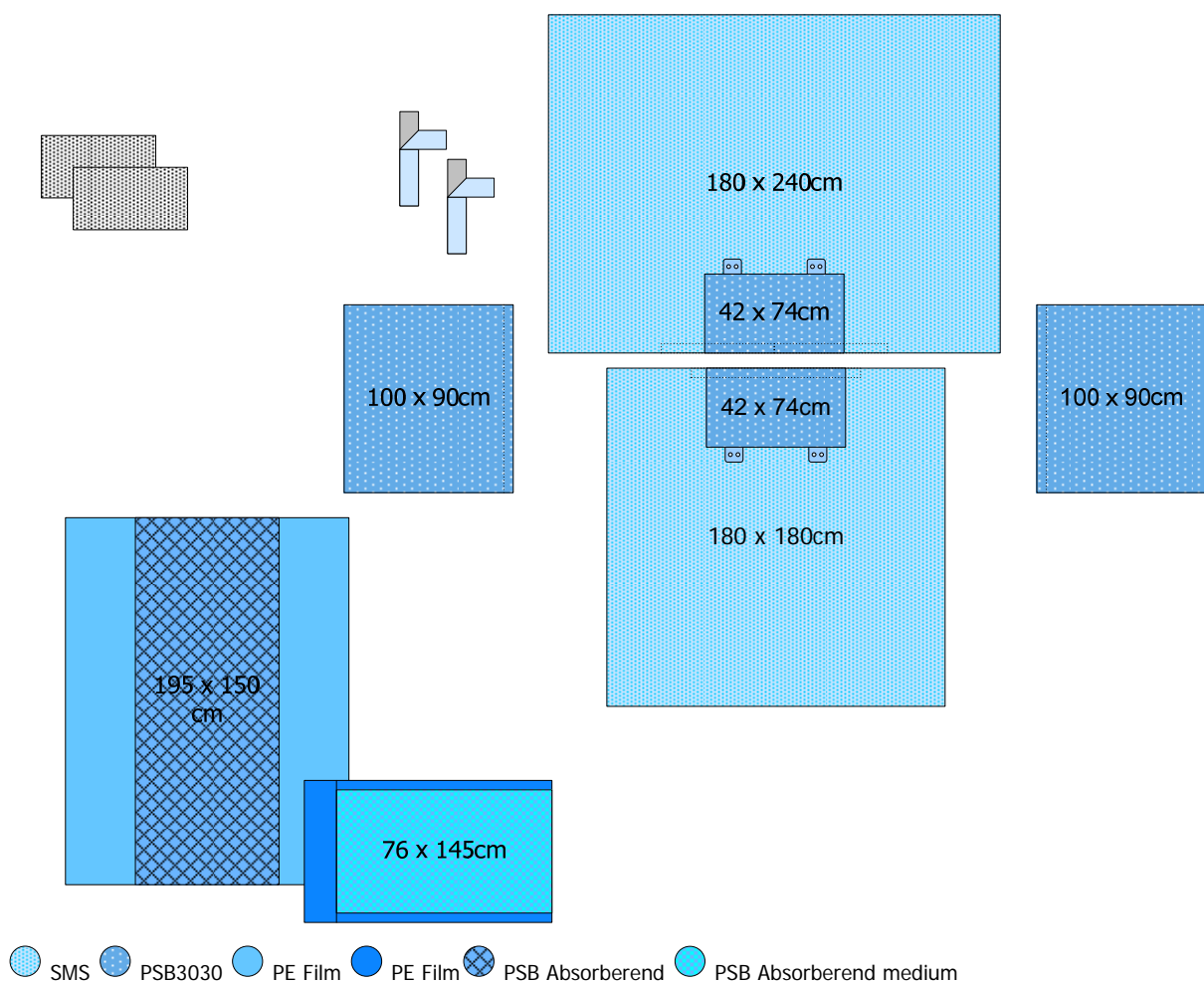

11000EG Universeel pakket SMS

Omschrijving	aantal	Component nummer	afmetingen
Bovenlaken	1	1301880	180 x 240 cm
Zijlaken	2	1302383	100 x 90 cm
Onderlaken	1	1301881	180 x 180 cm
Instrumentenveld	1	1306755	195 x 150 cm
Overzettafelsloop	1	1301901	76 x 145 cm
Tapestrip	2	1301916	10 x 50 cm
Handdoekje	2	1307245	34 x 61 cm

12 pakketten per doos

2.2 Universeel kinderpakket SMS

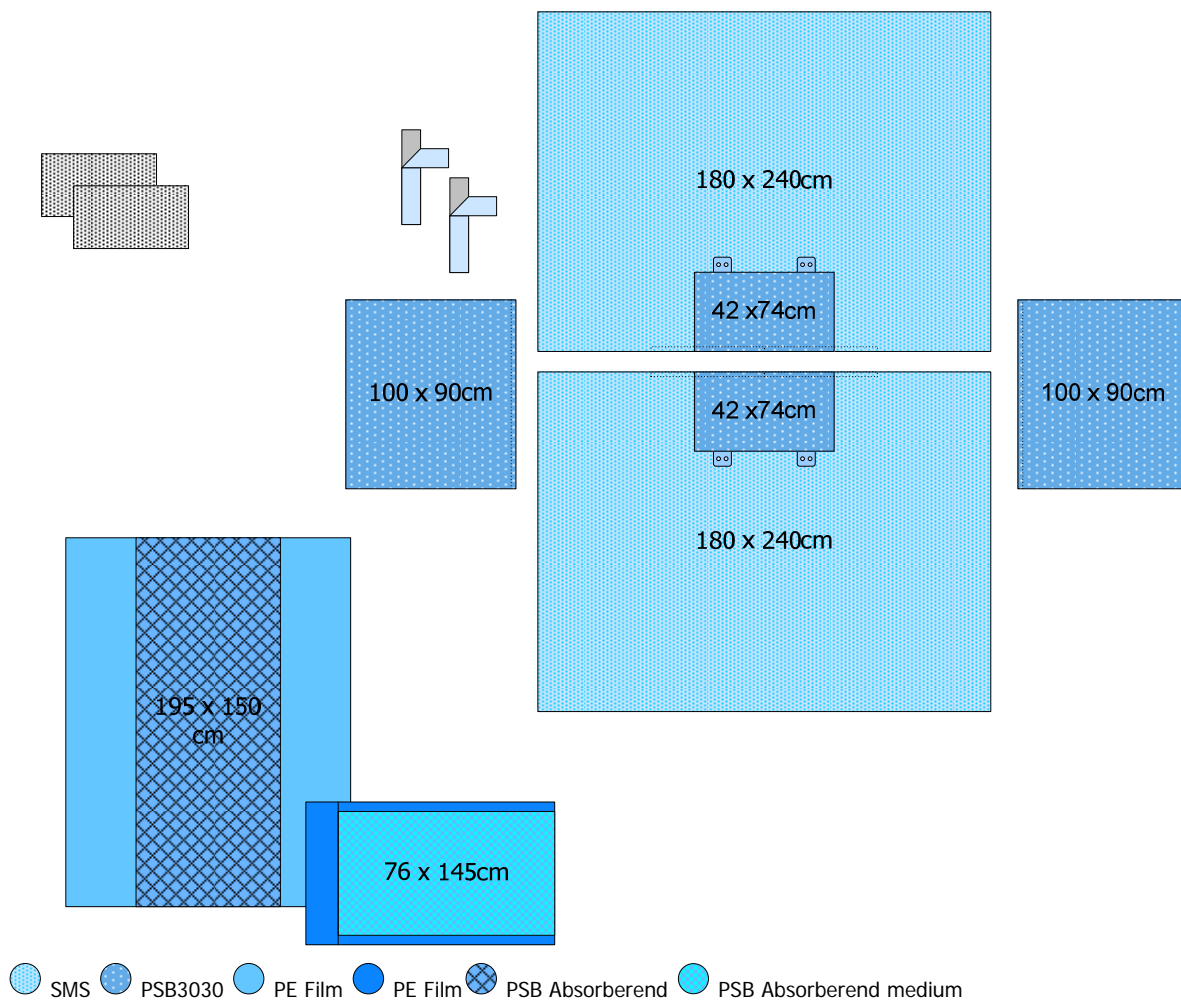

11012EG Universeel kinderpakket SMS

Omschrijving	aantal	Component nummer	afmetingen
Bovenlaken	1	1307255	180 x 240 cm
Zijlaken	2	1307256	100 x 90 cm
Onderlaken	1	1307255	180 x 180 cm
Instrumentenveld	1	1306755	195 x 150 cm
Overzettafelsloop	1	1301901	76 x 145 cm
Tapestrip	2	1301916	10 x 50 cm
Handdoekje	2	1307245	34 x 61 cm

12 pakketten per doos

2.3 Universeel Pakket Prestico®

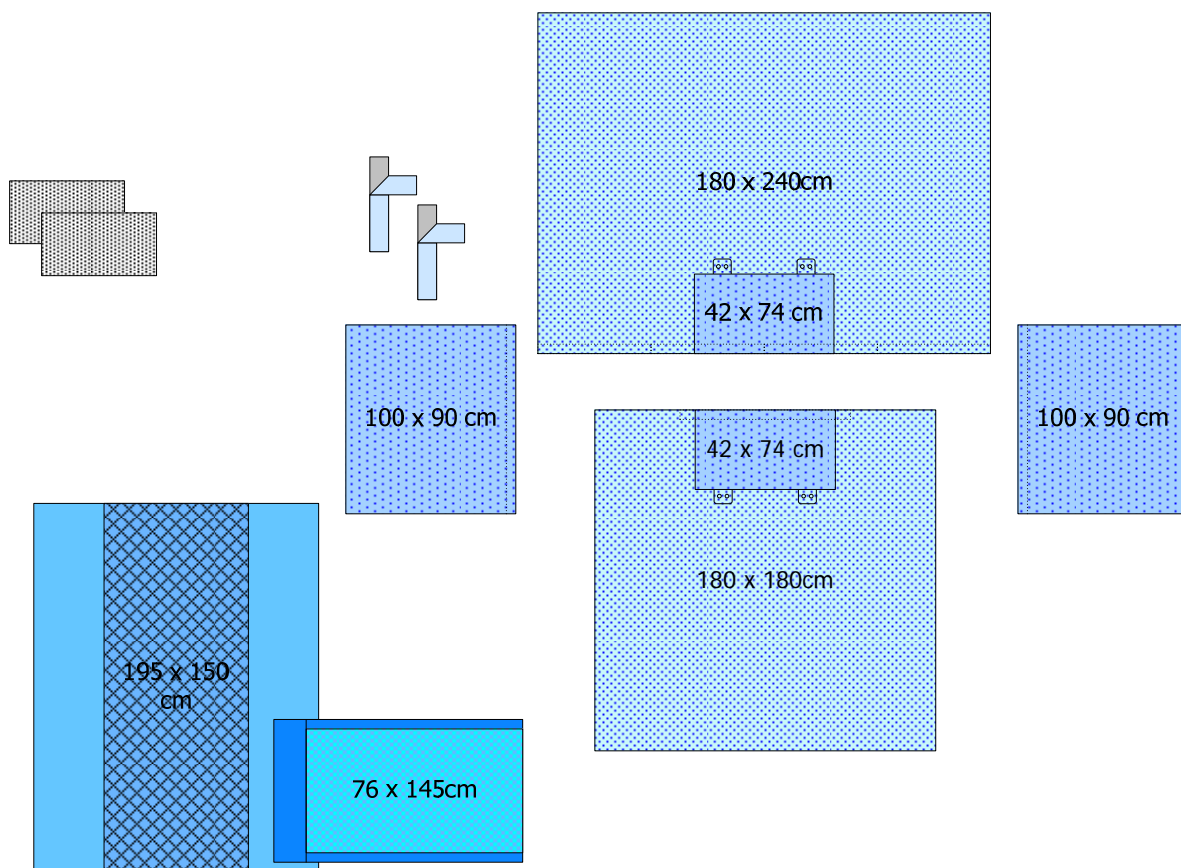

 Prestico®
  SM Pad
  PE Film
  PE Film
  PSB Absorberend
  PSB Absorberend medium

106171AA Universeel pakket Prestico®

Omschrijving	aantal	Component nummer	afmetingen
Bovenlaken	1	1302462	180 x 240 cm
Zijlaken	2	1307074	100 x 90 cm
Onderlaken	1	1302472	180 x 180 cm
Instrumentenveld	1	1306755	195 x 150 cm
Overzettafelsloop	1	1301901	76 x 145 cm
Tapestrip	1	1302102	10 x 50 cm
Handdoekje	2	1306929	30,5 x 42,5cm

XX pakketten per doos

2.4 Universeel U-Bar pakket 3-laags

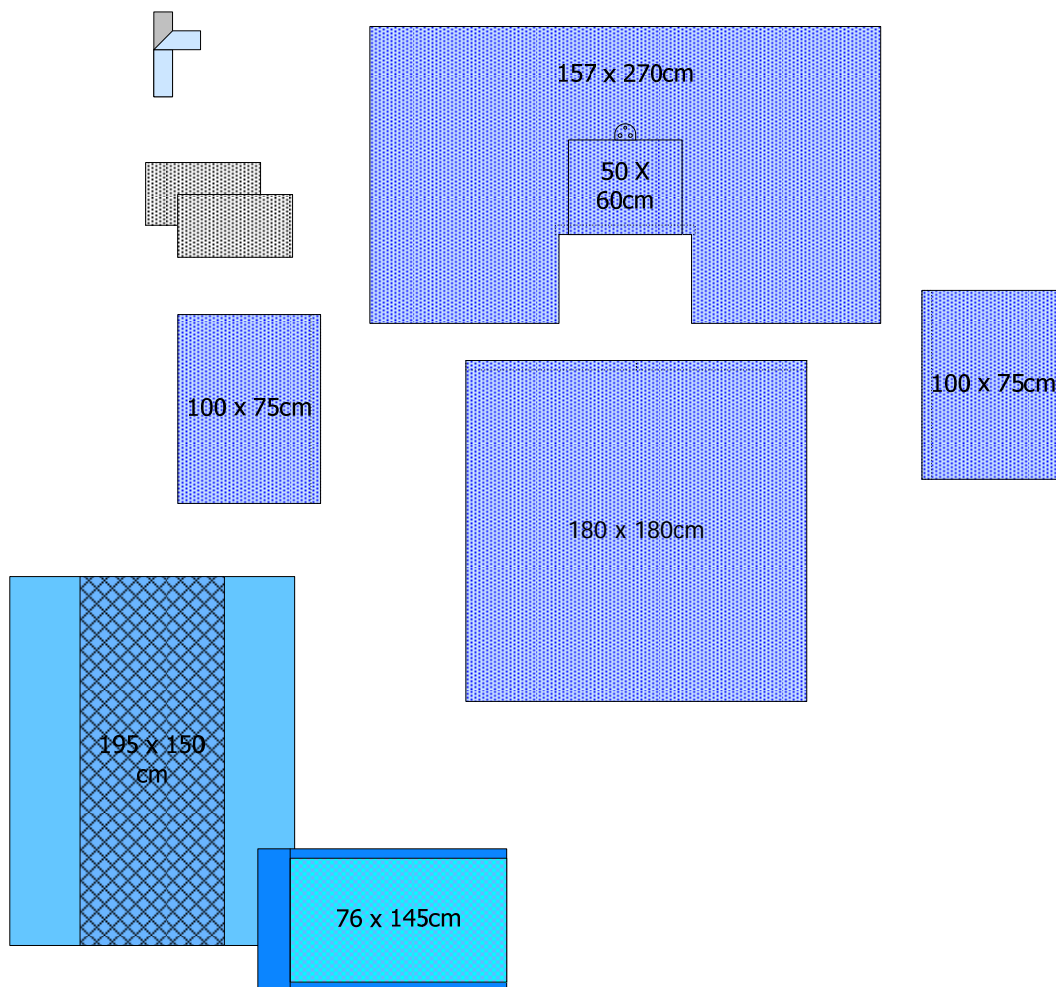

● 3-laags
 ● PE Film
 ● PE Film
 ● PSB Absorberend
 ● PSB Absorberend medium

11001EG Universal U-Bar Pack

Omschrijving	aantal	Component nummer	afmetingen
Bovenlaken	1	1307176	157 x 270 cm
Zijlaken	2	1301918	100 x 75 cm
Onderlaken	1	1302169	180 x 180 cm
Instrumentenveld	1	1306755	195 x 150 cm
Overzettafelsloop	1	1301901	76 x 145 cm
Tapestrip	1	1301916	10 x 50 cm
Handdoekje	2	1307245	34 x 61 cm

10 pakketten per doos

2.5 Splitlaken pakket Prestico®

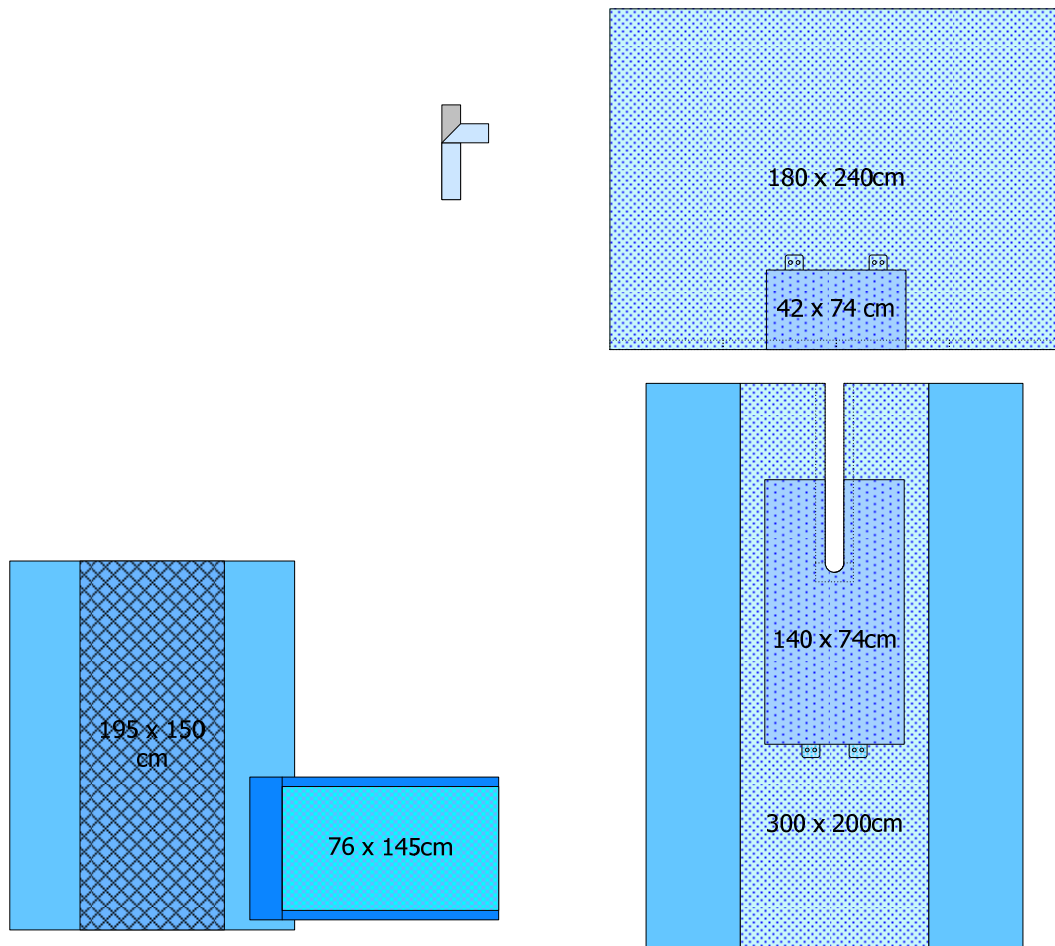

Prestico®
 SM Pad
 PE Film
 PE Film
 PSB Absorberend
 PSB Absorberend medium

106172AA Splitlaken pakket Prestico®

Omschrijving	aantal	Component nummer	afmetingen
Bovenlaken	1	1302462	180 x 240 cm
Splitlaken, split 10 x 100 cm	1	1302323	300 x 200 cm
Instrumentenveld	1	1306755	195 x 150 cm
Overzettafelsloop	1	1301901	76 x 145 cm
Tapestrip	1	1302102	10 x 50 cm
XX pakketten per doos			

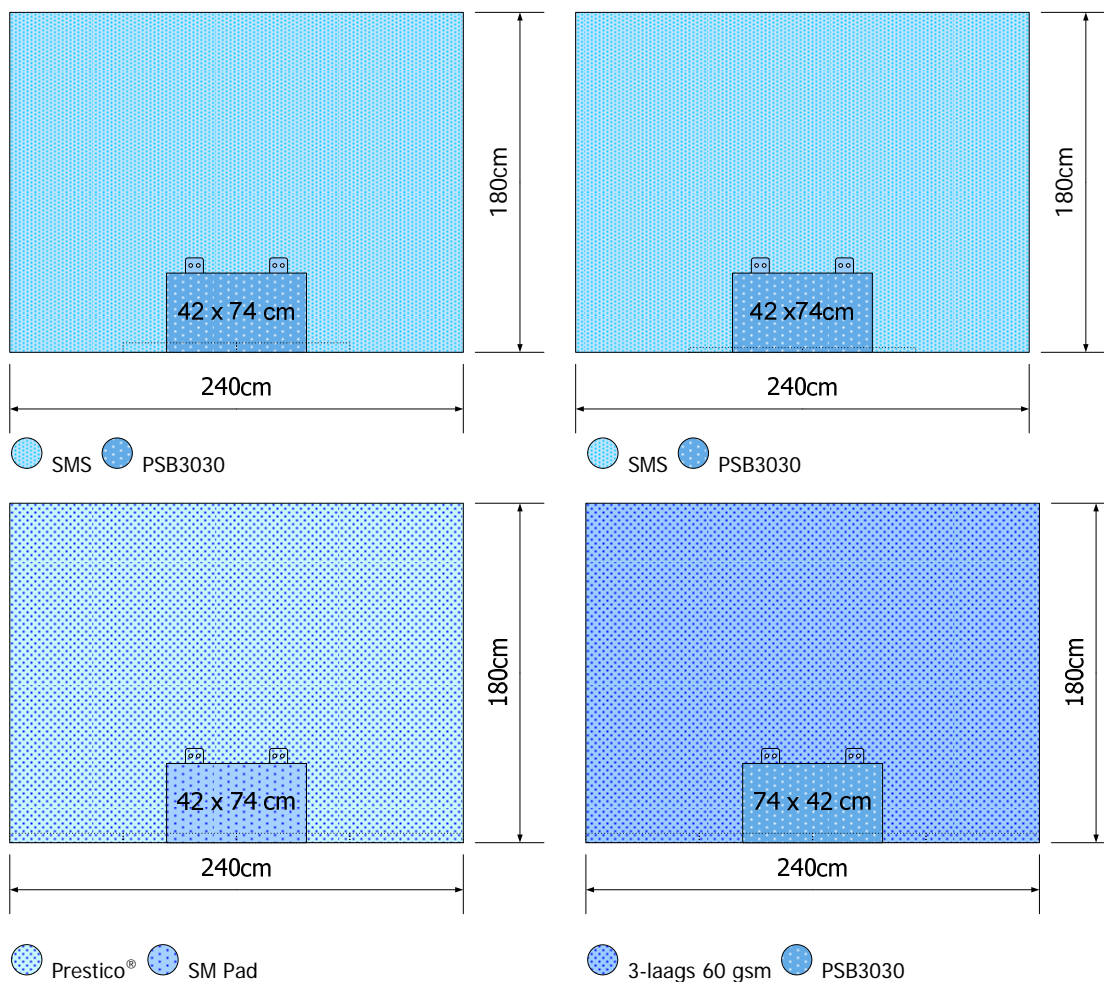

2.6 Bovenlakens

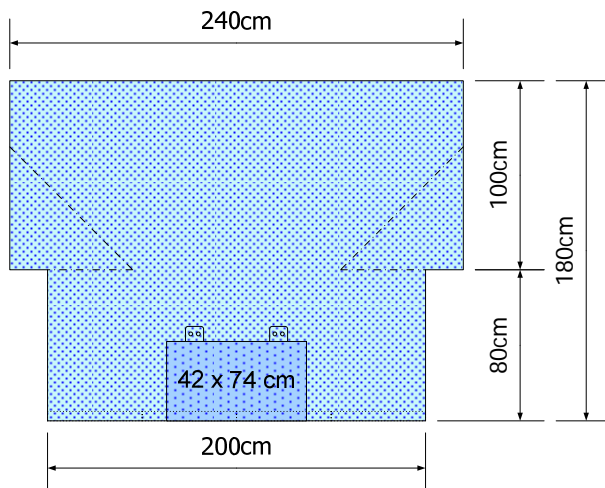

Materiaal	Afmeting	Component nummer	Bestel nummer	Aantal per doos	Bestel nummer	Aantal per doos
			steriel		steriel	
			Standaard verpakking		Eco verpakking	
SMS	180 x 240 cm	1301880	105113AA		11029EG	34
SMS (Tape 2,5cm)	180 x 240 cm	1307255	106173AA		11142EG	
Prestico®	180 x 240 cm	1302462	106174AA			
3-laags 60 gsm	180 x 240 cm	1302168	105260AA			
Tape 5 cm (1307255 tape is 2,5cm)						
Absorberende zone 42 x 74 cm						
2 Slangenhouders						

2.6 Bovenlakens (vervolg)



 Prestico®
  SM Pad

Materiaal	Afmeting	Component nummer	Bestel nummer	Aantal per doos	Bestel nummer	Aantal per doos
			steriel		steriel	
			Standaard verpakking		Eco verpakking	
Prestico®	180 x 200/240 cm	1302468	106175AA			

Armsteun bedekkingen

Absorberende zone 42 x 74 cm

2 Slangenhouders

Tape 5 cm

2.6 Bovenlakens (vervolg)

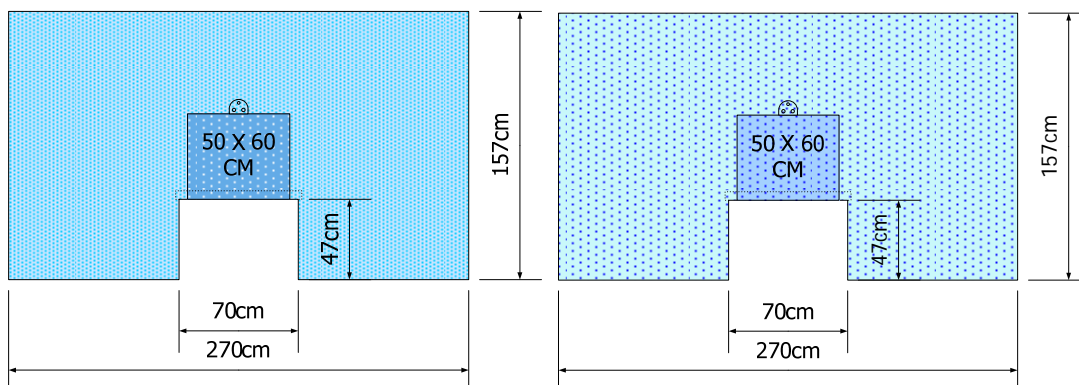

● SMS ● PSB3030

● Prestico® ● SM Pad

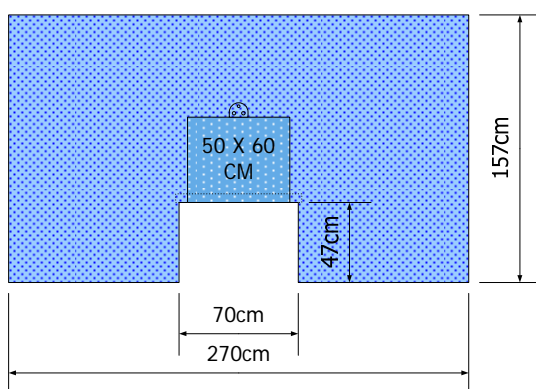

● 3-laags 60 gsm ● PSB3030

Materiaal	Afmeting	Component nummer	Bestel nummer	Aantal per doos	Bestel nummer	Aantal per doos
			steriel		steriel	
				Standaard verpakking		Eco verpakking
SMS	157 x 270 cm	1307138	106176AA			
Prestico®	157 x 270 cm	1302322	105021AA			
3-laags 60 gsm	157 x 270 cm	1307176	106177AA			

Slanghouder

Versterkte zone 50 x 60 cm

Tape 5 x 74cm

2.7 Onderlakens

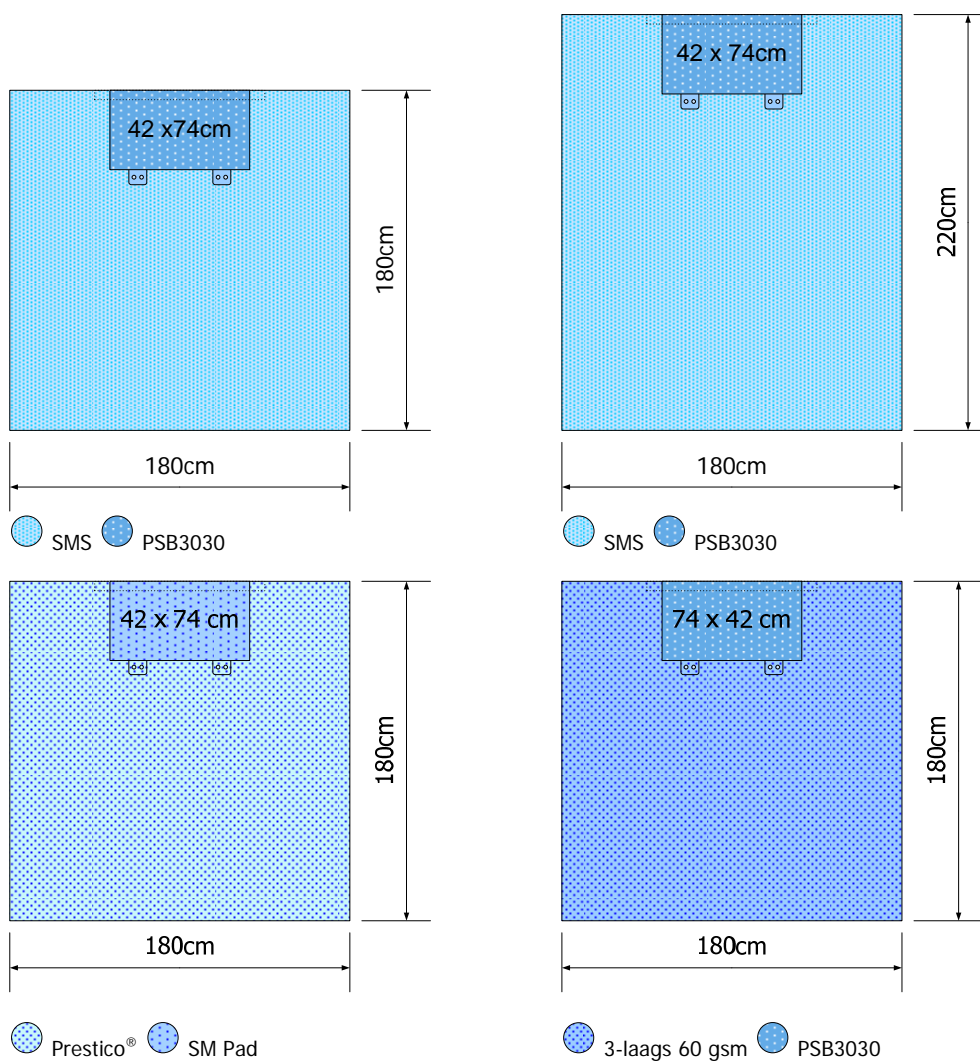

Materiaal	Afmeting	Component nummer	Bestel nummer	Aantal per doos	Bestel nummer	Aantal per doos
					steriel	steriel
					Standaard verpakking	Eco verpakking
SMS	180 x 180 cm	1301881	105683AA	10	11031EG	35
SMS	220 x 180 cm	1301980	106178AA		11033EG	35
Prestico®	180 x 180 cm	1302472	106179AA			
3-laags 60 gsm	180 x 180 cm	1302169	105003AA	20		

Tape 5 cm

Absorberende zone 42 x 74 cm

2 Slangenhouders

2.8 Zijlakens

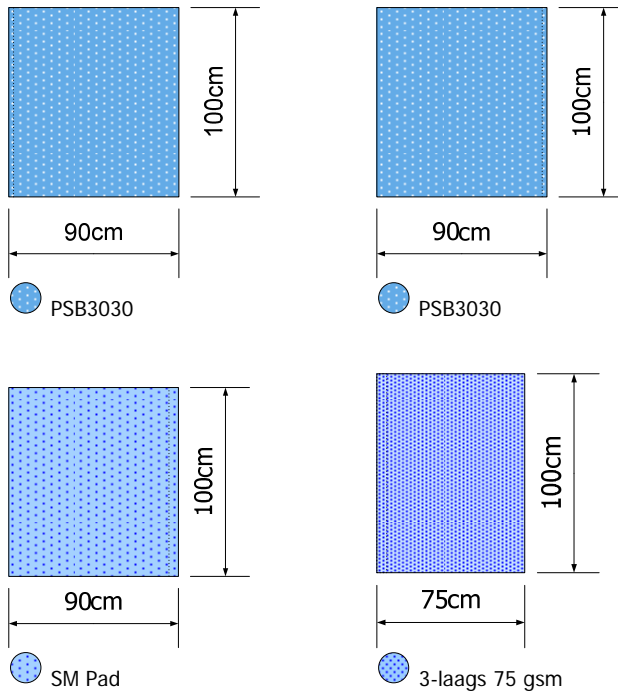

Materiaal	Afmeting	Component nummer	Bestel nummer	Aantal per doos	Bestel nummer	Aantal per doos
			steriel		steriel	
			Standaard verpakking		Eco verpakking	
PSB3030 (5cm tape)	100 x 90 cm	1302383	106180AA			
PSB3030 (2,5cm tape)	100 x 90 cm	1307256	106181AA		11143EG	
SM	100 x 90 cm	1307074	103640AA	50		
3-laags 75 gsm	100 x 75 cm	1301918	106182AA		11036EG	

2.9 Splitlakens

2.9.1 Splitlaken 300x200cm, split 6x94cm

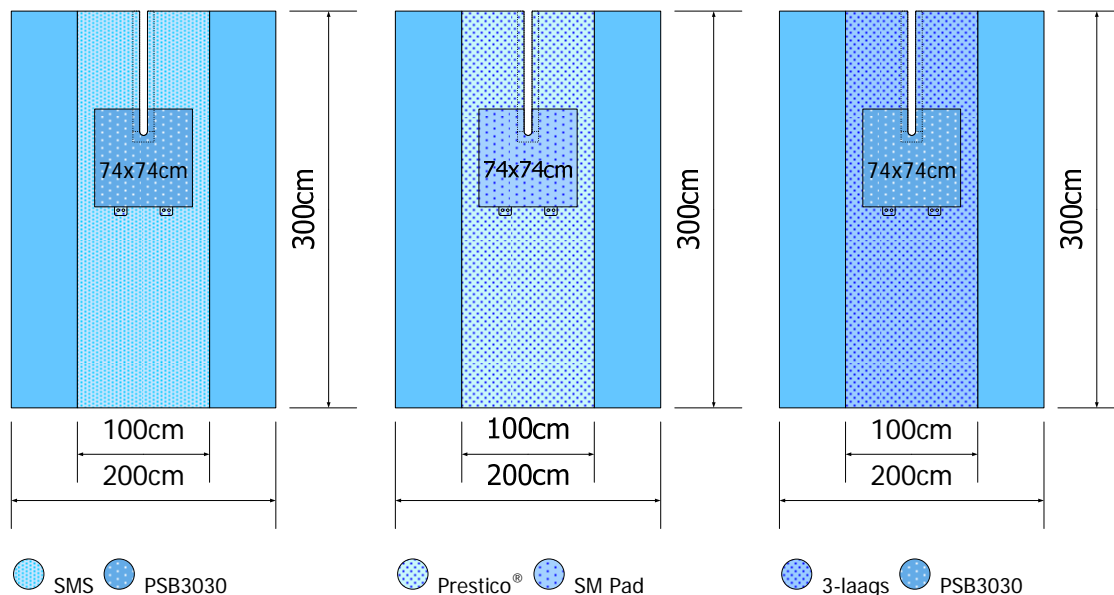

Materiaal	Afmeting	Component nummer	Bestel nummer steriel	Aantal per doos	Bestel nummer steriel	Aantal per doos
					Eco verpakking	
SMS	300 x 200 cm	1302556	106183AA			
Prestico®	300 x 200 cm	1302463	106016AA			
3-laags	300 x 200 cm	1302311				

Tape 5 cm

2 Slangenhouders

2.9.2 Splitlaken 180x240cm, split 10x50cm

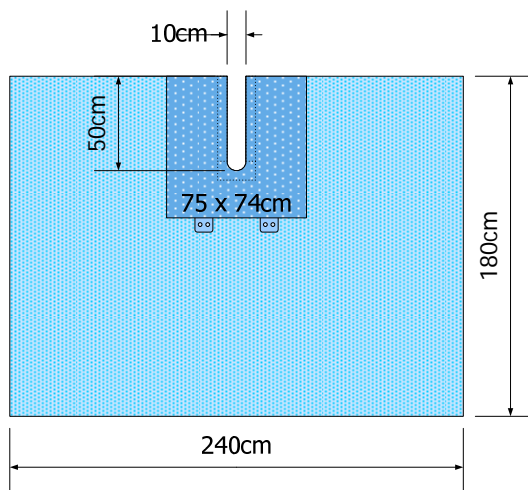

 SMS
  PSB3030

Materiaal	Afmeting	Component nummer	Bestel nummer	Aantal per doos	Bestel nummer	Aantal per doos
			steriel		steriel	
			Standaard verpakking		Eco verpakking	
SMS	180 x 240 cm	1301982	106184AA		11037EG	25
Tape 5 cm						
2 Slangenhouders						

2.9.3 Splitlaken 300x200cm, split 10x100cm

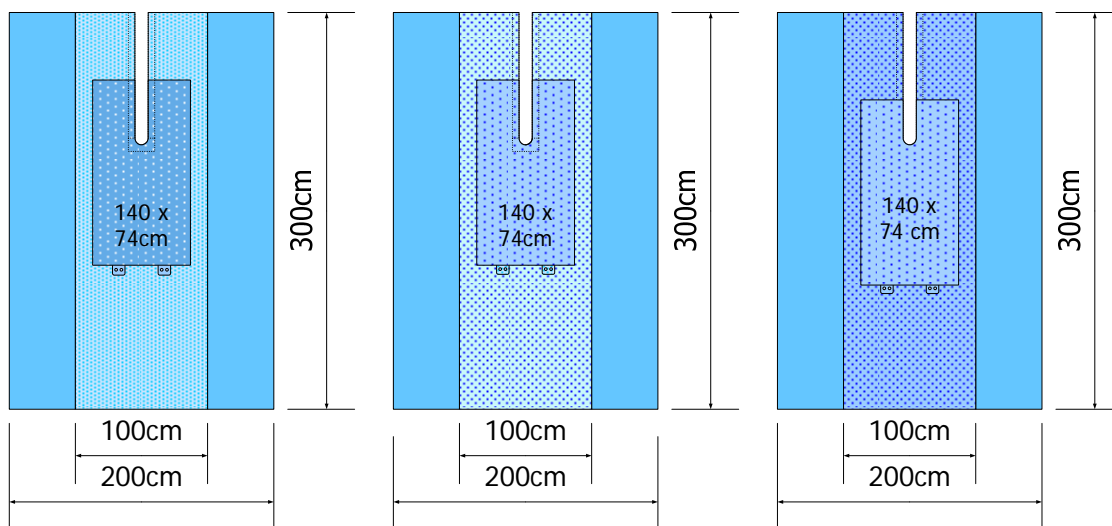

● SMS ● PSB3030

● Prestico® ● SM Pad

● 3-laags 60 gsm ● SM Pad



Materiaal	Afmeting	Component nummer	Bestel nummer steriel	Aantal per doos	Bestel nummer steriel	
					Standaard verpakking	Eco verpakking
SMS	300 x 200 cm	1301920	106185AA		11038EG	28
Prestico®	300 x 200 cm	1302323	105020AA	10		
3-laags 60 gsm	300 x 200 cm	1307253				

Tape 5 cm

2 Slangenhouders

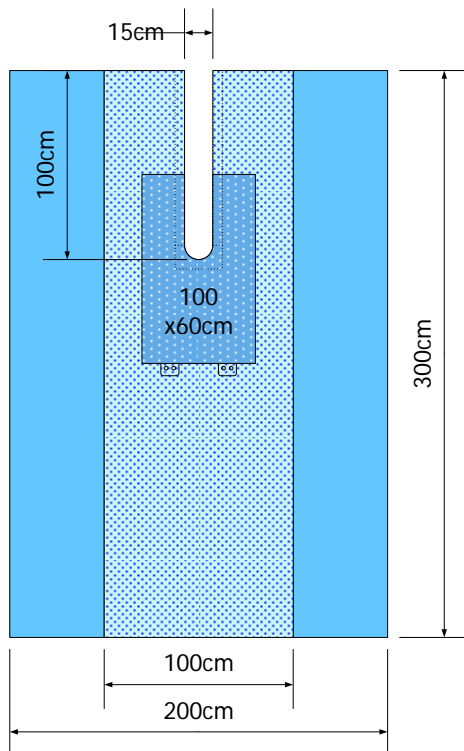
2.9.4 Splitlaken 300x200cm, split 15x100cm



 Prestico®
  SM Pad

Materiaal	Afmeting	Component nummer	Bestel nummer	Aantal	Bestel nummer	Aantal
			steriel	per doos	steriel	per doos
Prestico®	300 x 200 cm	1302469	Standaard verpakking		Eco verpakking	
			106186AA			

Tape 5 cm

2 Slangenhouders

2.9.5 Splitlaken 320x200cm, split 15x140cm

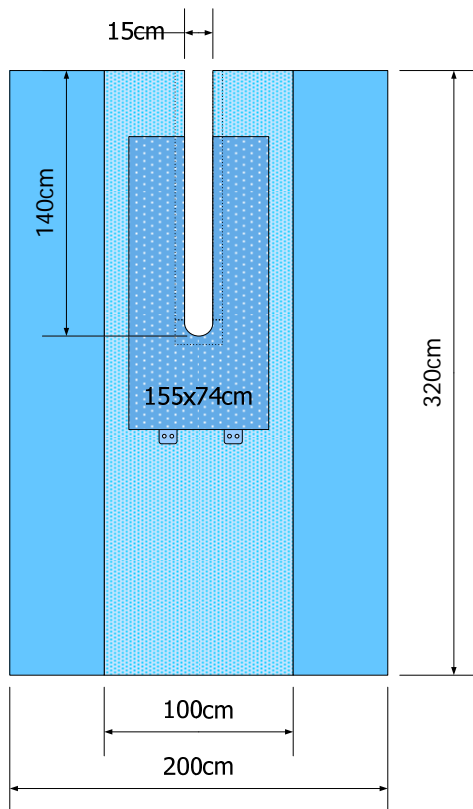

 SMS
  PSB3030

Materiaal	Afmeting	Component nummer	Bestel nummer steriel	Aantal per doos	Bestel nummer steriel	Aantal per doos
					Standaard verpakking	Eco verpakking
SMS	320 x 200 cm	1307267	104030AA	20		
Tape 5 cm						
2 Slangenhouders						

2.9.6 Splitlaken 260x200cm, split 20x100cm

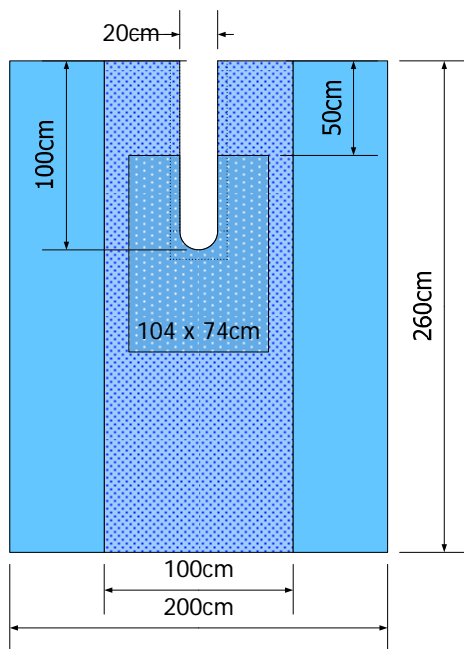



● 3-laags ● PSB3030

Materiaal	Afmeting	Component nummer	Bestel nummer steriel	Aantal per doos	Bestel nummer steriel	Aantal per doos
			Standaard verpakking		Eco verpakking	
3-laags	260 x 200 cm	1307211				
Tape 5 cm						

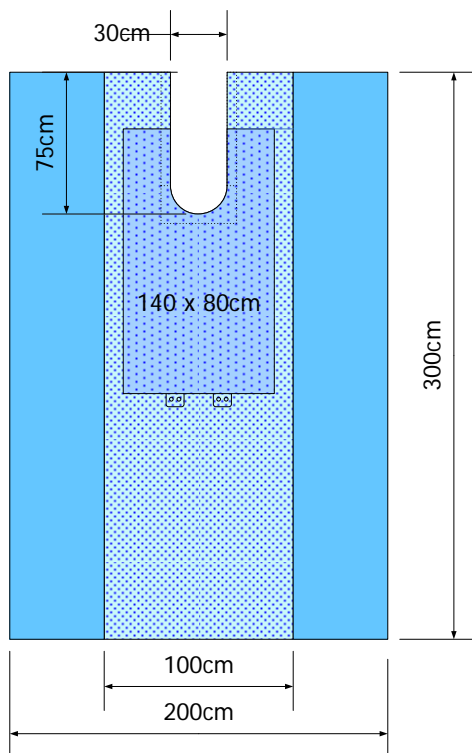
2.9.7 Splitlaken 300x200cm, split 30x75cm



 Prestico®
  SM Pad

Materiaal	Afmeting	Component nummer	Bestel nummer steriel	Aantal per doos	Bestel nummer steriel	Aantal per doos
Prestico®	300 x 200 cm	1302324	106187AA	Standaard verpakking	Eco verpakking	
Tape 5 cm						
2 Slangenhouders						

2.9.8 Splitlaken 185x140cm, split 15x55cm

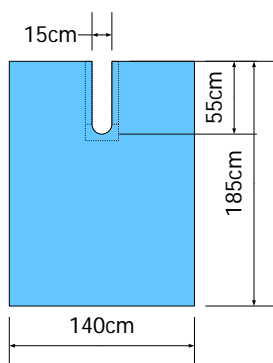



● Polyethyleen film

Materiaal	Afmeting	Component nummer	Bestel nummer steriel	Aantal per doos	Bestel nummer steriel	Aantal per doos
PE Film	185 x 140 cm	1306954	103466AA	30		
			Standaard verpakking		Eco verpakking	
Tape 5 cm						

2.10 Laparotomie lakens

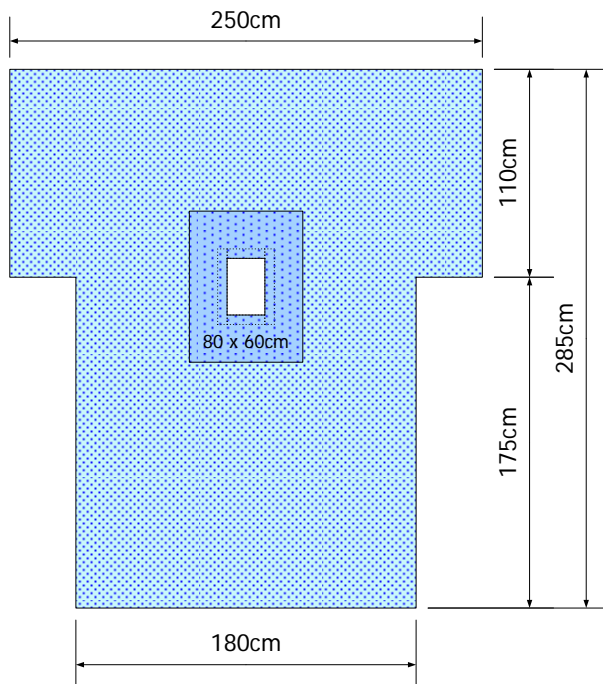
2.10.1 Laparotomie laken 285 x 180/250cm, Prestico®



 Prestico®
  SM Pad



Materiaal	Afmeting	Component nummer	Bestel nummer steriel	Aantal per doos	Bestel nummer steriel	Aantal per doos
Prestico®	285x180/250 cm	1302475	106105AA			
			Standaard verpakking		Eco verpakking	

Venster 20 x 30 cm

Tape 5 cm

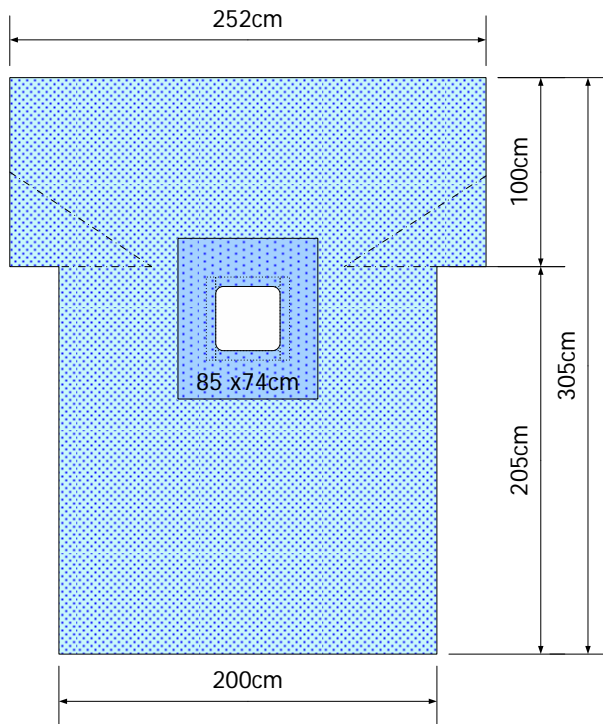
2.10.2 Laparotomie laken 305x200/252 cm, Prestico®



 Prestico®
  SM Pad

Materiaal	Afmeting	Component nummer	Bestel nummer steriel	Aantal per doos	Bestel nummer steriel	Aantal per doos
Prestico®	305x200/252 cm	1302481	106188AA	Standaard verpakking	Eco verpakking	
Venster 34 x 34 cm						
Armsteun bedekkingen						
Tape 5 cm						

2.10.3 Laparotomie laken 355x190/300 cm

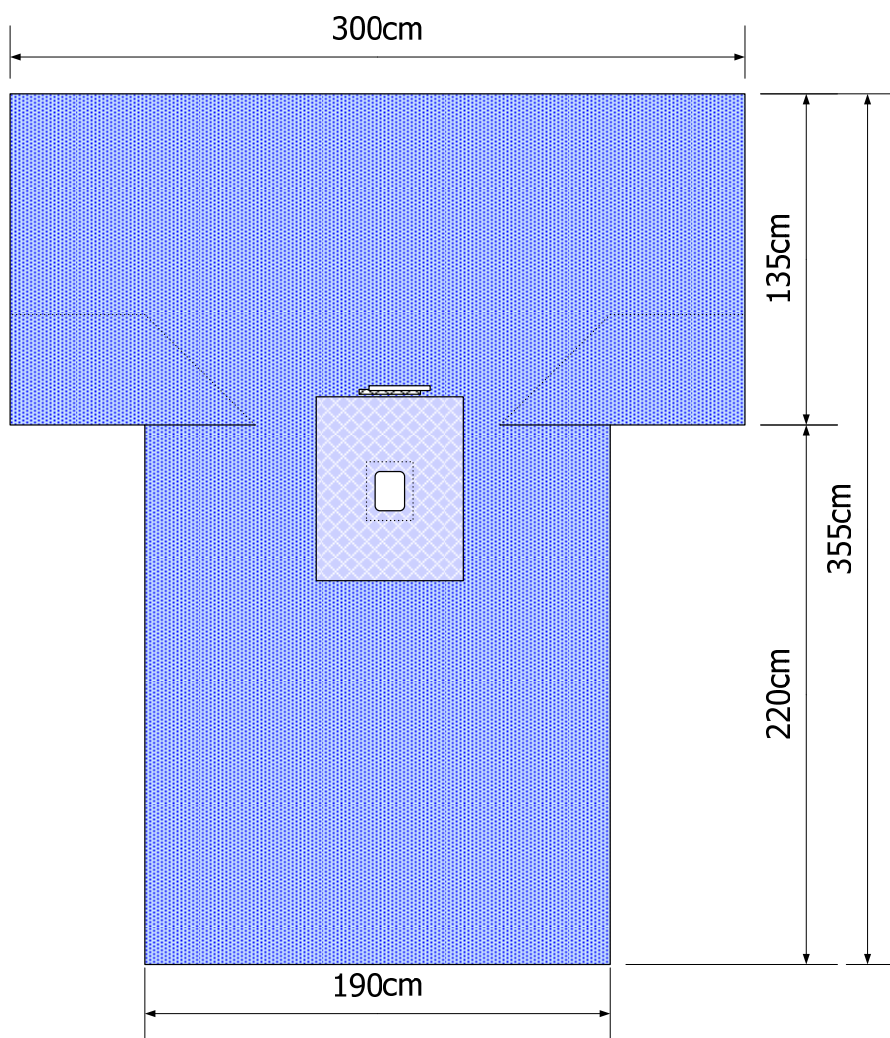

Materiaal	Afmeting	Component nummer	Bestel nummer steriel	Aantal per doos	Bestel nummer steriel	Aantal per doos
				Standaard verpakking		Eco verpakking
3-laags	355x190/300 cm	1302022				
Venster 16 x 12 cm						
Velcro 2 x 25 cm						
Absorptie 75 x 60 cm						
Armsteun bedekkingen						
Tape 5 cm						

2.11 Algemene lakens

2.11.1 Instrumentenvelden

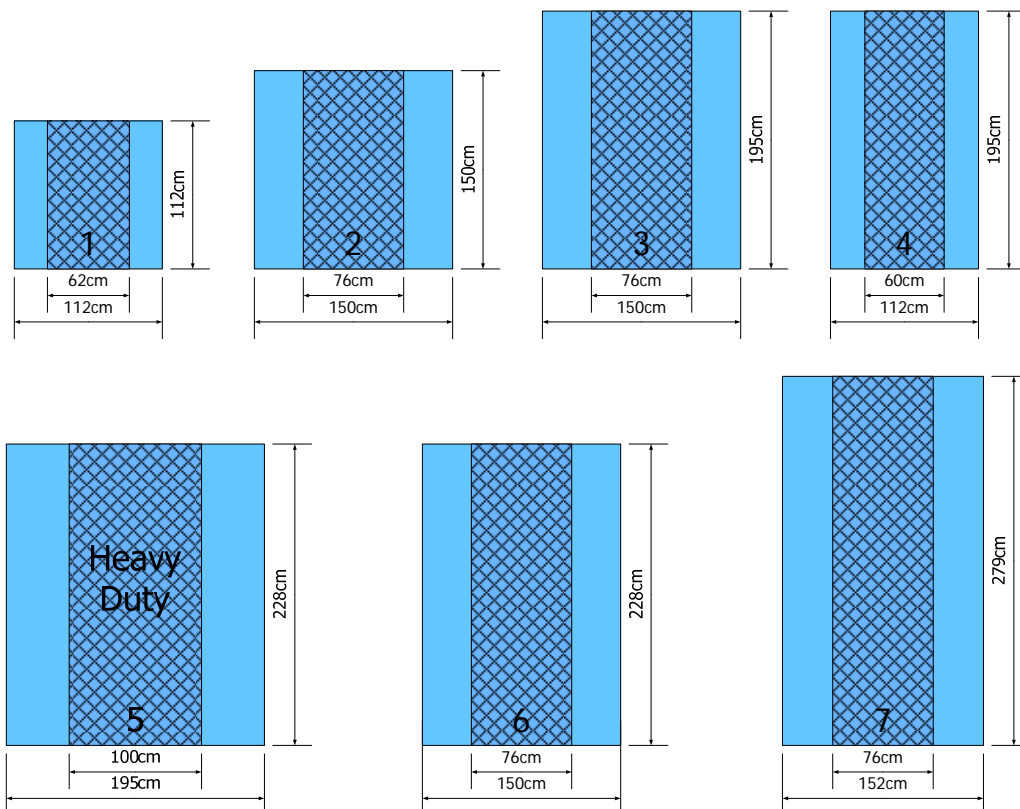

● Polyethyleen film ● PSB Absorberend

Afmeting	Component nummer	Order nummer		Aantal per doos	Order nummer	
		steriel	steriel		steriel	steriel
		Standaard verpakking			Eco verpakking	
1 112 x 112 cm	1301958	104550AA	60			
2 150 x 150 cm	1306754	103621AA	20		11144EG	
3 195 x 150 cm	1306755	103622AA	20		11052EG	45
4 195 x 112 cm	1306756	103623AA	20			
5 228 x 195 cm	1306757	103624AA	20			
6 228 x 150 cm	1306758	103635AA	20			
7 279 x 152 cm	1306759	103636AA	20			

Polyethyleen film, 60 gram/m²

No. 5 Heavy Duty, Polyethyleen film, 70 gram/m²

2.11.2 Overzet-tafelsloop

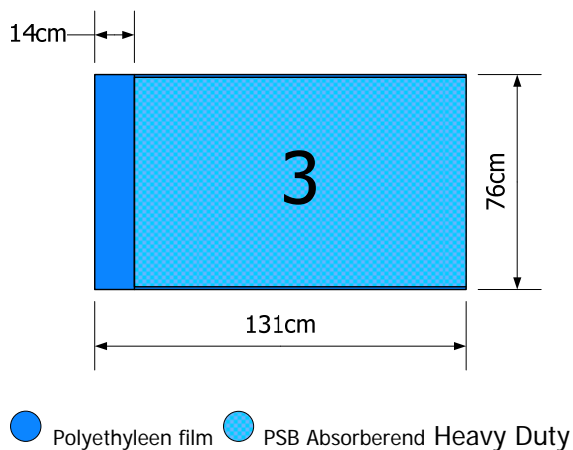
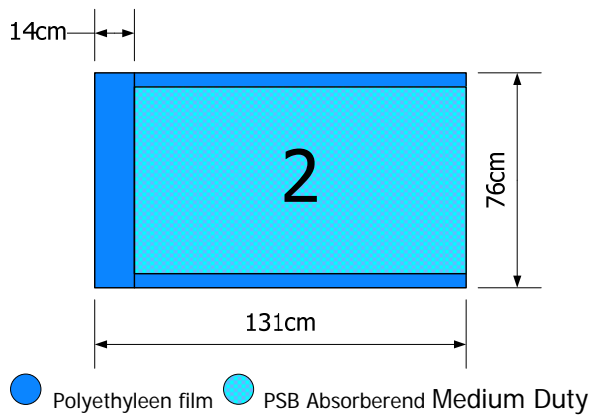
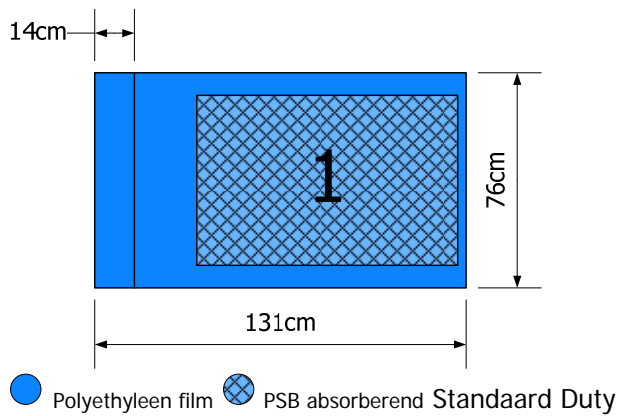

Afmeting	Component nummer	Order nummer steriel	Aantal per doos	Order nummer steriel	Aantal per doos
				Eco verpakking	
1 76 x 145cm	1306760	103848AA	100		
2 76 x 145cm	1301901	103694AA	60	11053EG	76
3 76 x 145cm	1301902	103849AA	40		

2.11.3 Tissue Laminaat lakens

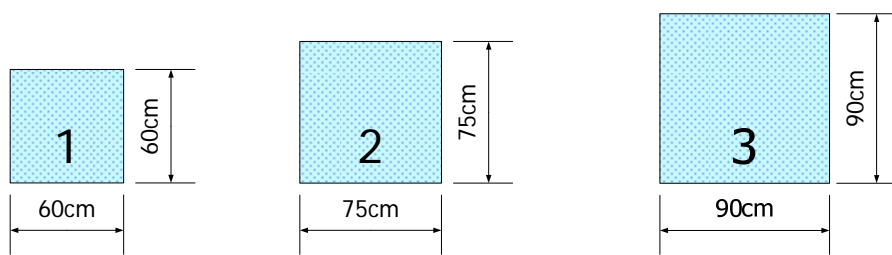

 Tissue Laminaat

Afmeting	Component nummer	Order nummer	Aantal per doos	Order nummer	Aantal per Doos
		steriel		steriel	
		Standaard verpakking		Eco verpakking	
1 60 x 60 cm	1302506				
2 75 x 75 cm	1302507				
3 90 x 90 cm	1302505				

2.11.4 SMS lakens

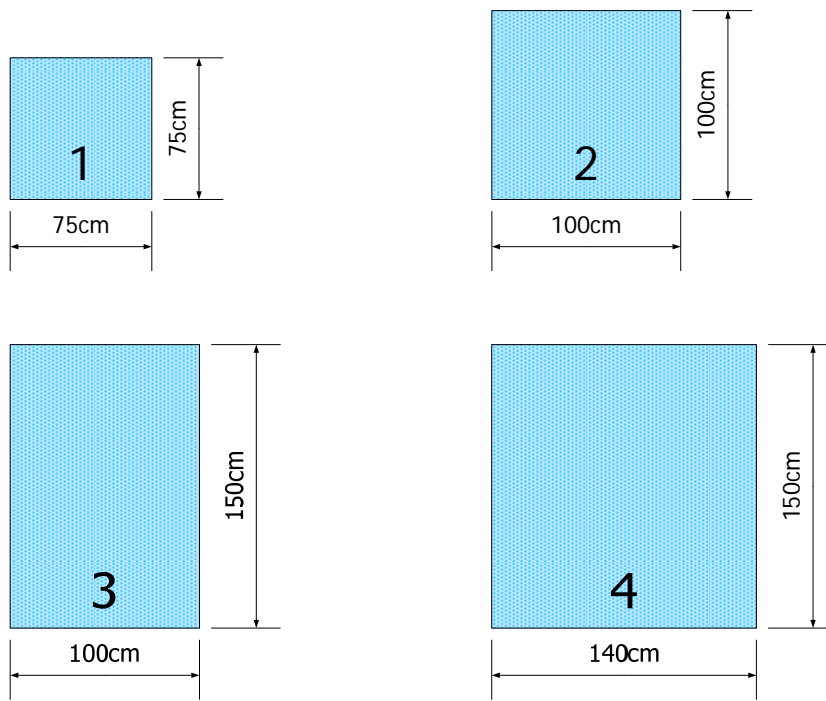

 SMS

Afmeting	Component nummer	Order nummer steriel		Aantal per Doos
		Standaard verpakking	Eco verpakking	
1 75 x 75 cm	1302227	106189AA	11039EG	
2 100 x 100 cm	1301927	106190AA	11040EG	136
3 100 x 150 cm	1302228	106191AA	11041EG	50
4 140 x 150 cm	1301921	106201AA	11042EG	54

2.11.5 Prestico® lakens

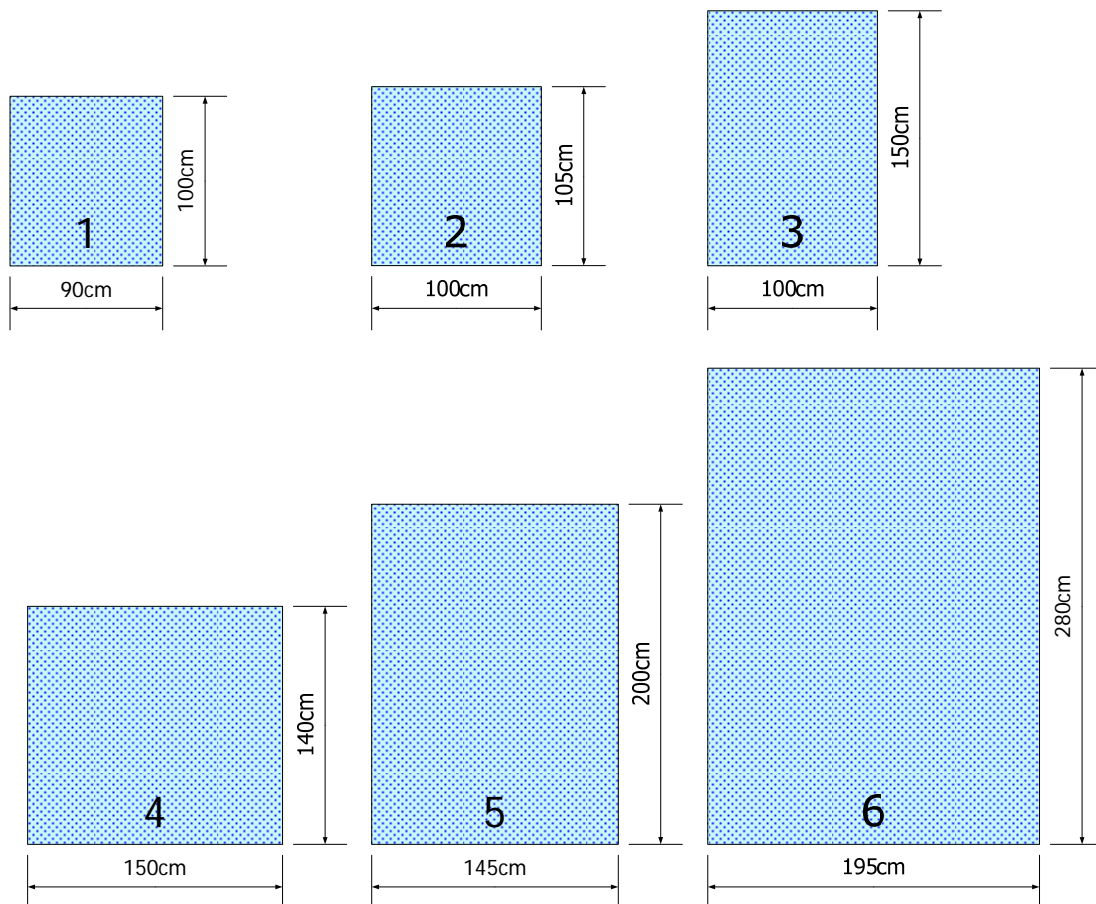

 Prestico®

	Afmeting	Component nummer	Order nummer	Aantal	Order nummer	Aantal
			steriel	per doos	steriel	per Doos
			Standaard verpakking		Eco verpakking	
1	100 x 90 cm	1302464	106202AA			
2	105 x 100 cm	1302467	106203AA			
3	150 x 100 cm	1302470	106204AA			
4	140 x 150 cm	1302474	106205AA			
5	200 x 145 cm	1302479	106206AA			
6	280 x 195 cm	1302488	106207AA			

2.11.6 2-laags lakens

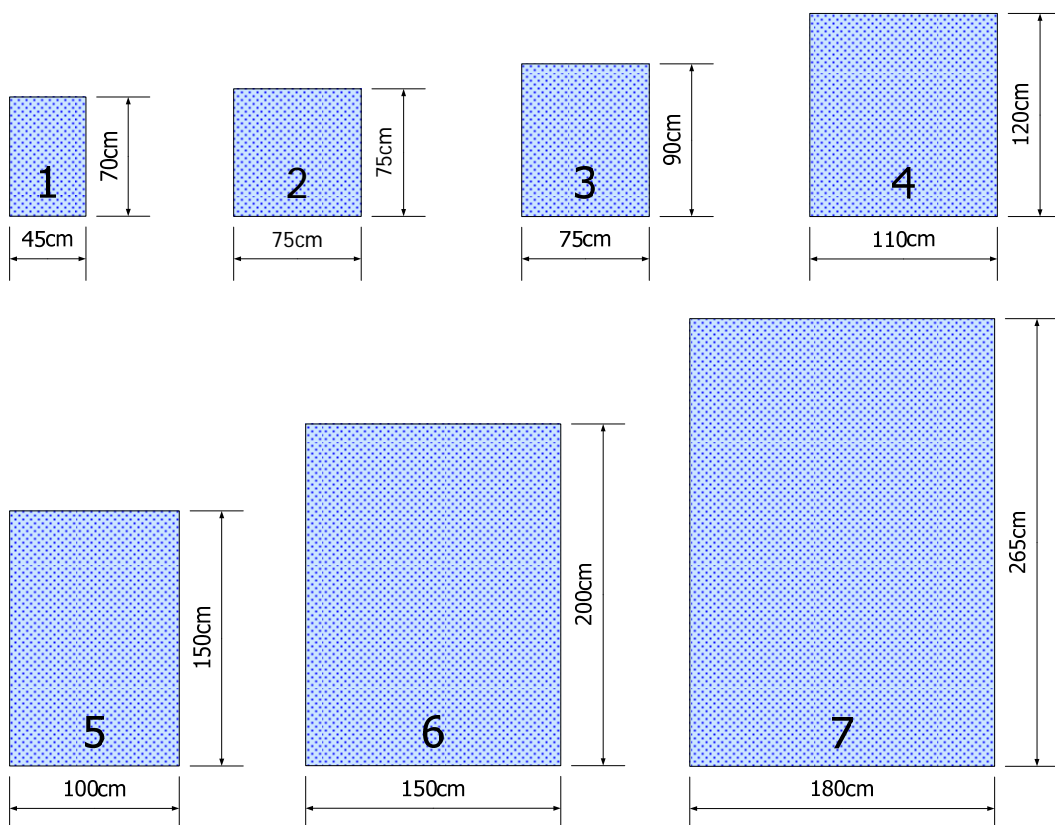

 2-laags

Afmeting	Component nummer	Order nummer		Order nummer	
		steriel	Aantal per doos	steriel	Aantal per Doos
		Standaard verpakking		Eco verpakking	
1 70 x 45 cm	1304099	103470AA	100		
2 75 x 75 cm	1309495			77004	4x25
3 90 x 75 cm	1309572			77001	4x25
4 120 x 110 cm	1301853	104529AA	60		
5 150 x 100 cm	1301336	104530AA	60		
6 200 x 150 cm	1304088	104531AA	40		
7 265 x 180 cm	1301975	104532AA			

2.11.7 Lakens met tape SMS

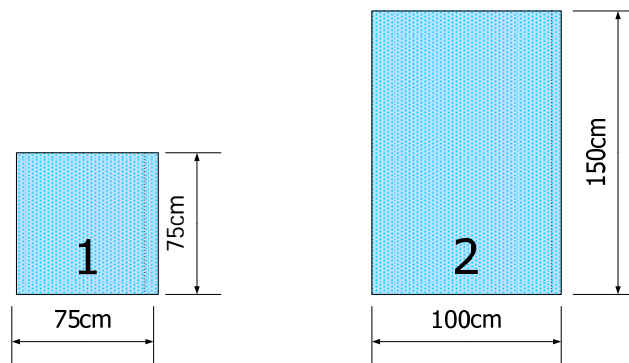

Afmeting	Component nummer	Order nummer	Aantal per doos	Order nummer	Aantal per Doos
		steriel		steriel	
			Standaard verpakking	Eco verpakking	
1 75 x 75 cm	1302229	106212AA		11045EG	2x55
2 100 x 150 cm	1302230	106213AA		11046EG	2x33

2.11.8 Lakens met tape 2-laags

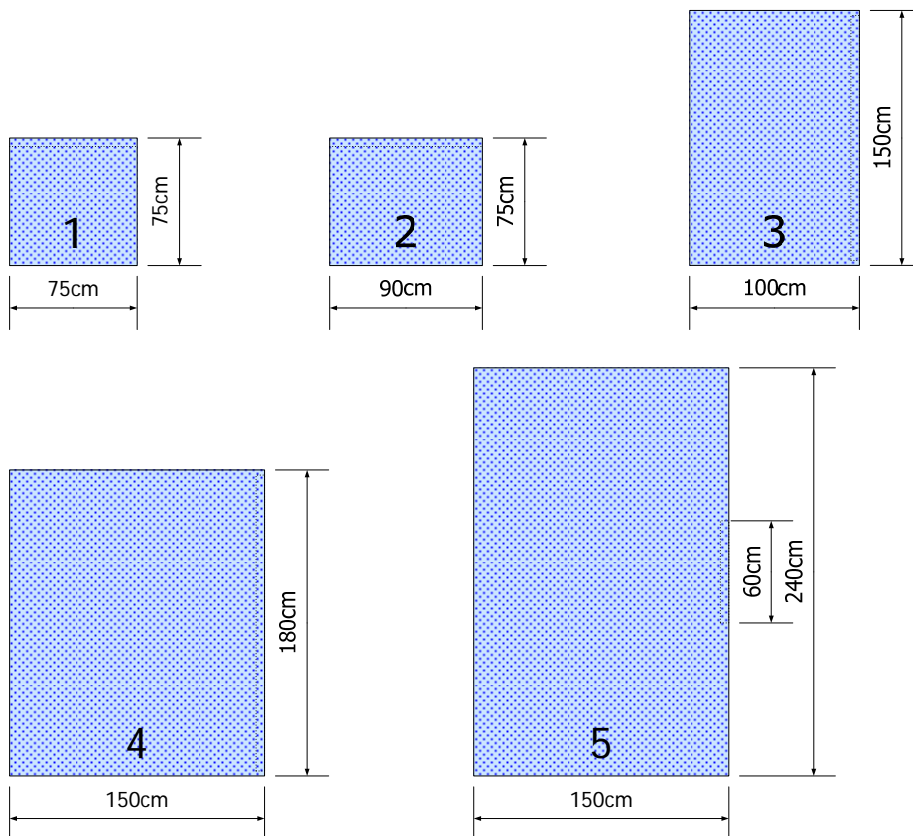

 2-laags

Afmeting	Component nummer	Order nummer		Aantal	
		steriel	per doos	per Doos	steriel
		Standaard verpakking	Eco verpakking		
1 75 x 75 cm	1309415				
2 90 x 75 cm	1309428			77000	4x25
3 150 x 100 cm	1304103	103682AA	20		
4 180 x 150 cm	1301446	104533AA	40		
5 240 x 150 cm	1301443	104534AA	30		

2.11.9 Lakens met tape 3-laags

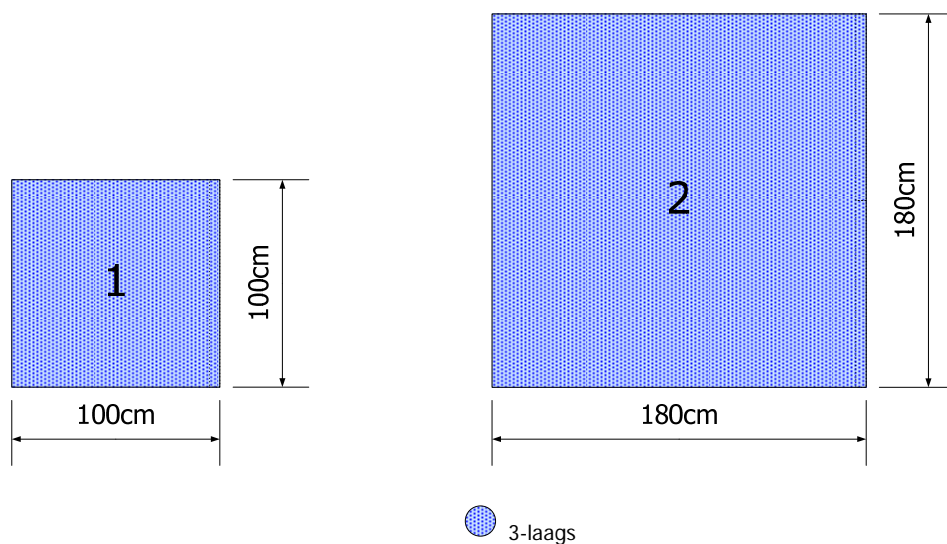

	Afmeting	Component nummer	Order nummer	Aantal	Order nummer	Aantal
			steriel	per doos	steriel	per Doos
			Standaard verpakking		Eco verpakking	
1	100 x 100 cm	1301933	106214AA		11044EG	2x30
2	180 x 180 cm	1301919	106215AA		11032EG	1x30

2.12 Lakens met Venster

2.12.1 Gatlakens Tissue Laminaat

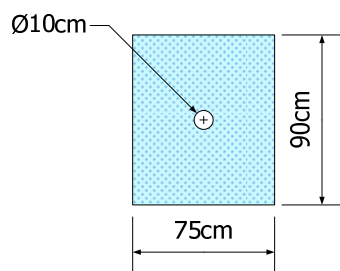

Afmeting	Component nummer	Order nummer steriel	Aantal per doos	Order nummer steriel	Aantal per Doos
90 x 75 cm Venster Ø 10 cm	1302504	Standaard verpakking		Eco verpakking	

2.13 Lakens met Venster en tape

2.13.1 Gatlakens 2-laags

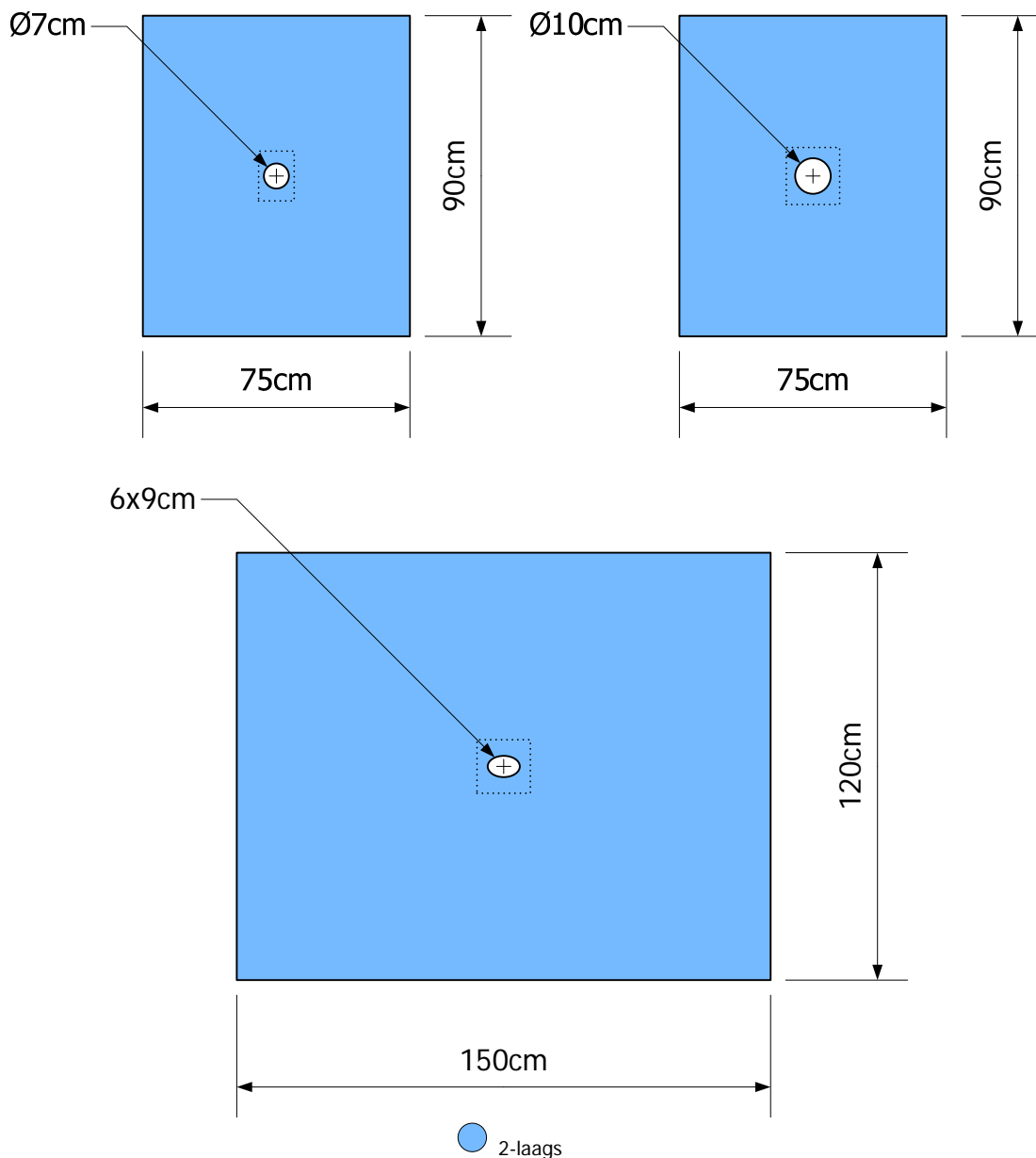

Afmeting	Component nummer	Order nummer	Aantal per doos	Order nummer	Aantal per Doos
		steriel		steriel	
		Standaard verpakking		Eco verpakking	
1 90 x 75 cm Venster \varnothing 7 cm	1301114			77003	4x30
2 90 x 75 cm Venster \varnothing 10 cm	1309403			77002	4x25
3 120 x 150 cm Venster 6x9cm	1301539	103474AA	10		

2.13.2 Gatlakens 3-laags

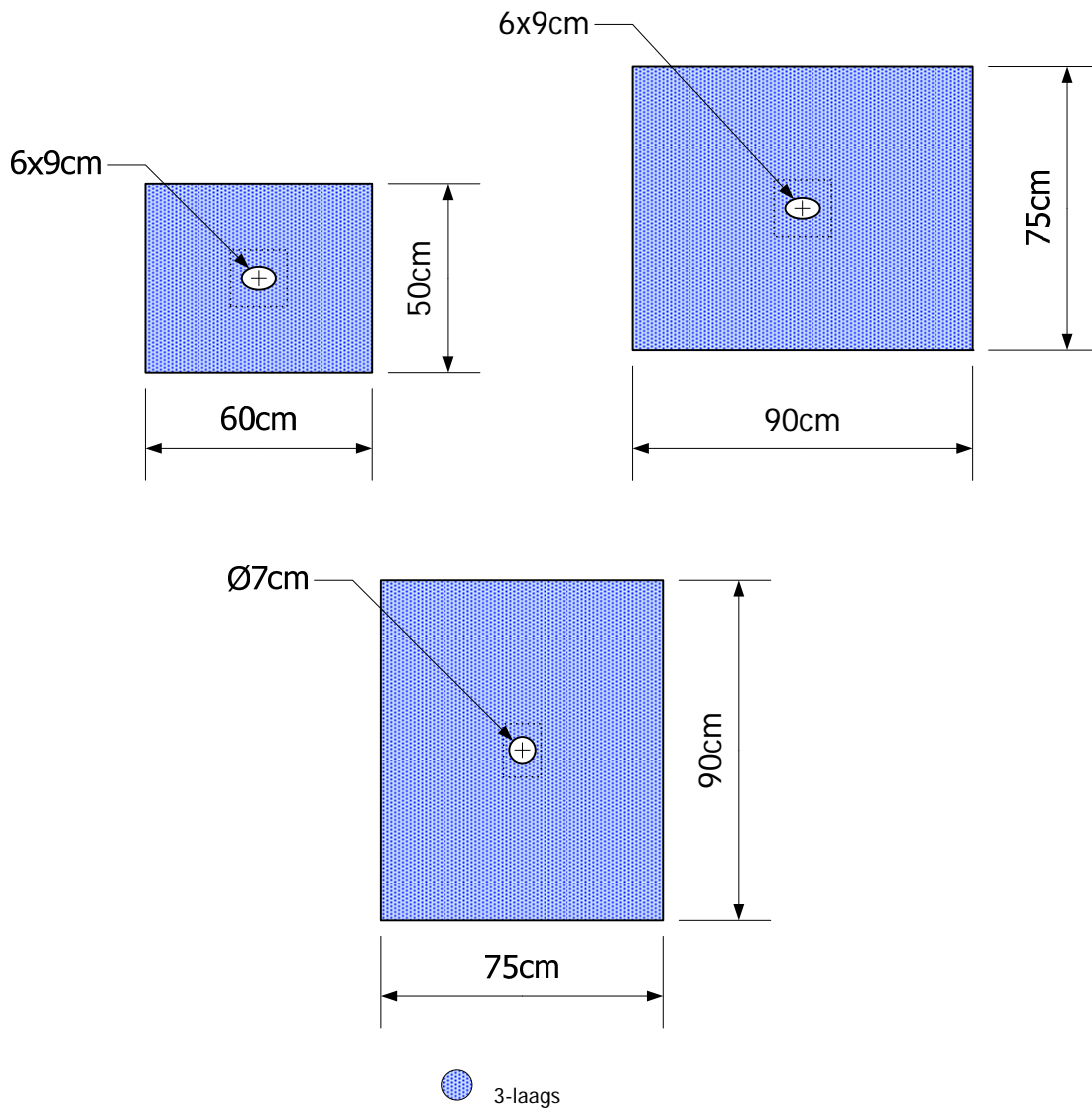

Afmeting	Component nummer	Order nummer	Aantal per doos	Order nummer steriel	Aantal per Doos steriel
				Standaard verpakking	Eco verpakking
1 50 x 60 cm Venster 6x9cm	1301441	103472AA	100		
2 75 x 90 cm Venster 6x9cm	1304055	103473AA	120		
3 90 x 75 cm Venster Ø 7 cm	1307381	94000	80		

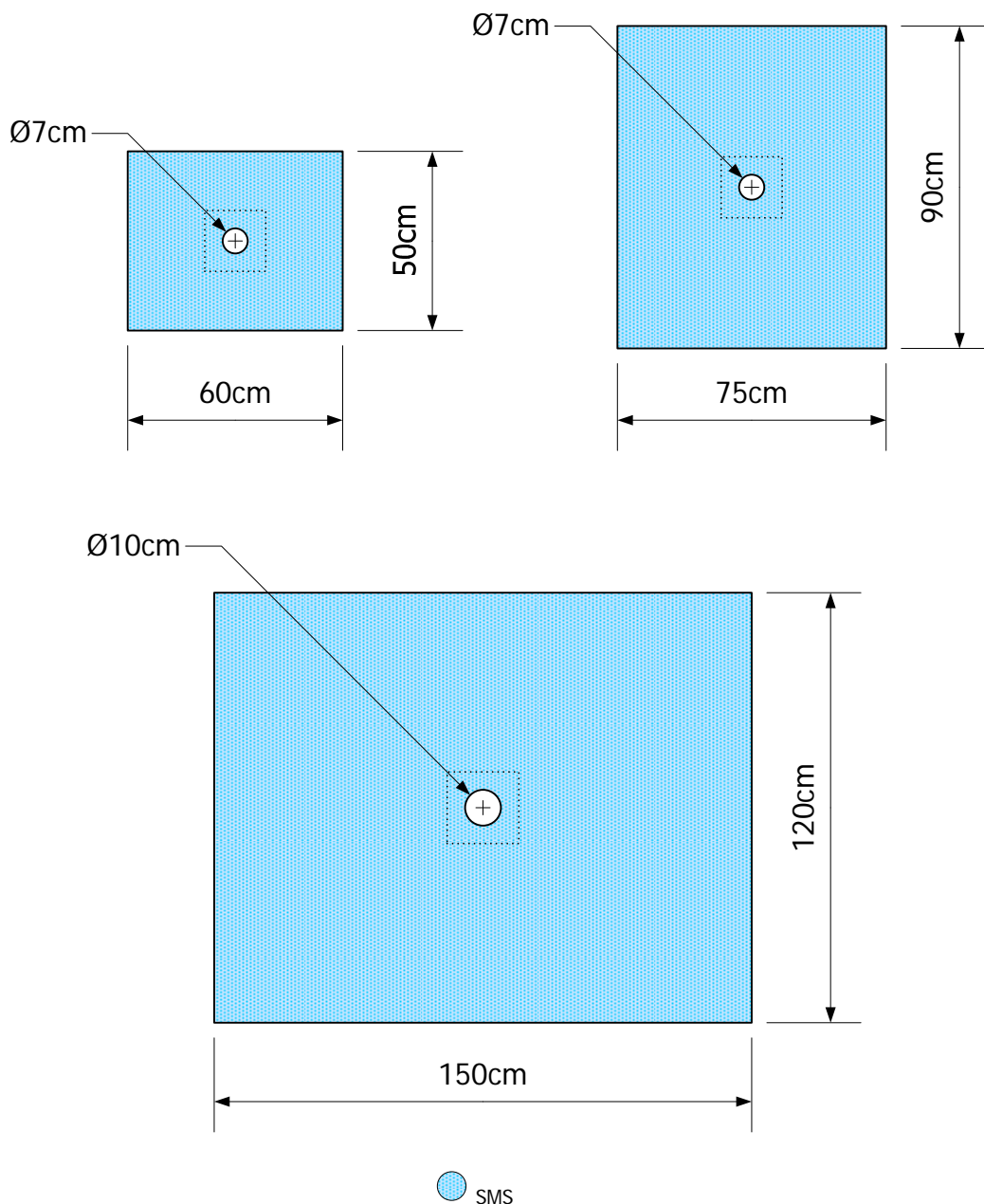

2.13.3 Gatlakens SMS

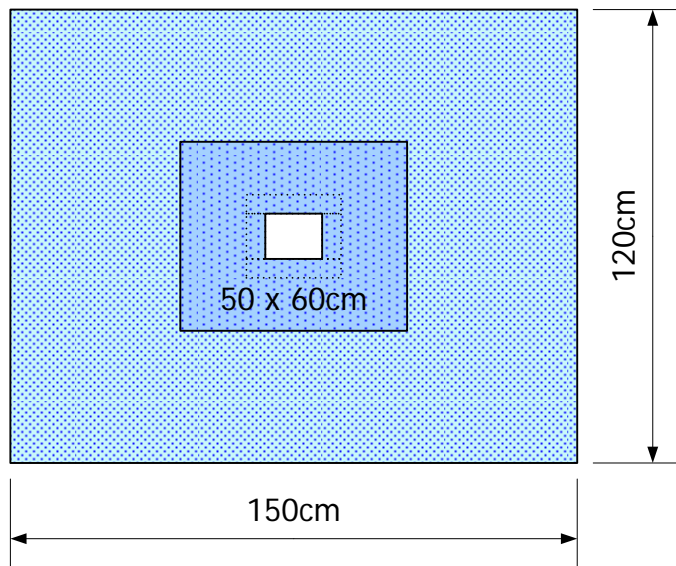

Afmeting	Component nummer	Order nummer	Aantal per doos	Order nummer	Aantal per Doos
		steriel		steriel	
		Standaard verpakking		Eco verpakking	
1 50 x 60 cm Venster $\varnothing 7$ cm	1302231	106222AA		11047EG	2x130
2 75 x 90 cm Venster $\varnothing 7$ cm	1302232	106263AA		11048EG	2x45
3 120 x 150 cm Venster $\varnothing 10$ cm	1302233	106264AA		11049EG	2x30

2.13.4 Gatlakens Prestico®



 Prestico®
  SM Pad

Materiaal	Afmeting	Component nummer	Bestel nummer steriel	Aantal per doos	Bestel nummer steriel	Aantal per doos
Prestico®	120 x 150 cm	1302485	106223AA	Standaard verpakking	Eco verpakking	
Venster van 12 x 15 cm						
Tape 22 x 25 cm met venster van 12 x 15 cm						

2.14 Variabel Venster lakens met tape

2.14.1 Variabel gatlaken 35x40cm 2-laags

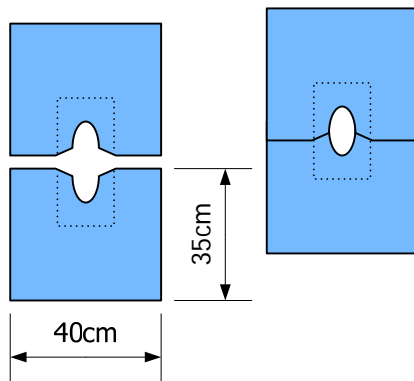

● 2-laags

Materiaal	Afmeting	Component nummer	Bestel nummer steriel	Aantal per doos	Bestel nummer steriel	Aantal per doos
			Standaard verpakking		Eco verpakking	
2-laags	35 X 40cm	1301238	103477AA	100 X 2		

2 artikelen in één verpakking

Maximum ovaal venster 7 x 14cm

Tape zone van 15 x 15 cm

2.14.2 Variabel gatlaken 75x120cm 2-laags

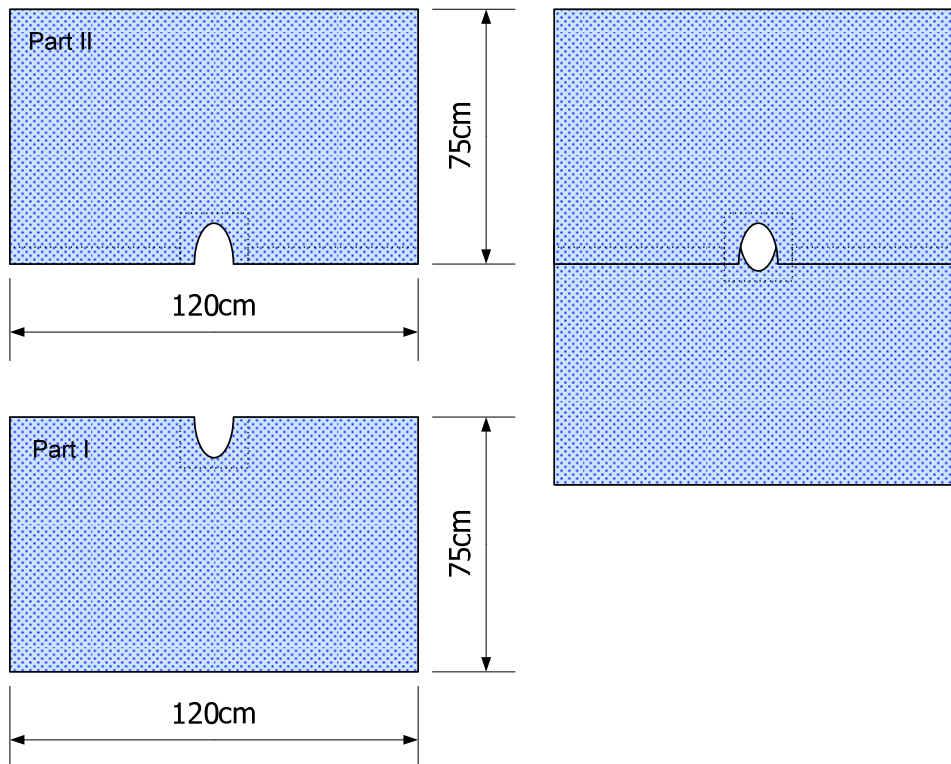

 2-laags

Materiaal	Afmeting	Component nummer	Bestel nummer steriel	Aantal per doos	Bestel nummer steriel	Aantal per doos
2-laags	75 X 120cm	1301578	104535AA	60		

Standaard verpakking	Eco verpakking

Deel I en II in één verpakking
 Maximaal ovaal Venster 24 x 12cm
 Tape 5cm

2.14.3 Variabel gatlaken 100x170cm SMS

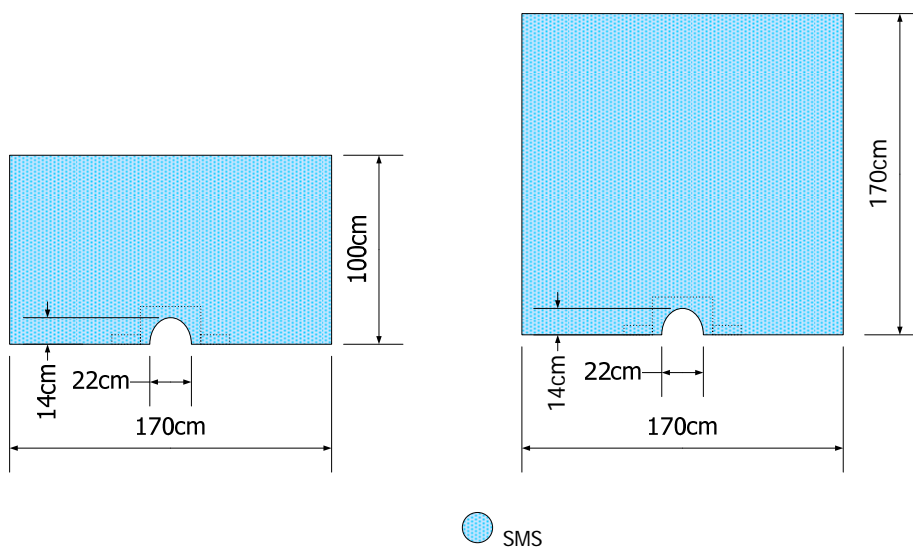

Materiaal	Afmeting	Component nummer	Bestel nummer steriel	Aantal per doos	Bestel nummer steriel	
					Standaard verpakking	Eco verpakking
SMS	100 X 170cm	1301923	106224AA		11050EG	88
SMS	170 x 170cm	1301931	106265AA		11051EG	48

Per stuk verpakt

2.15 Stuitlakens

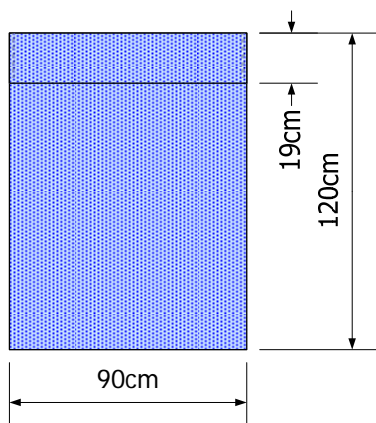

 3-laags

Materiaal	Afmeting	Component nummer	Bestel nummer	Aantal per doos	Bestel nummer	Aantal per doos
			steriel		steriel	
			Standaard verpakking		Eco verpakking	
3-laags	120 x 90 cm	1301924	106225AA		11058EG	

3 Orthopedie

3.1 Orthopedie splitlaken pakket SMS

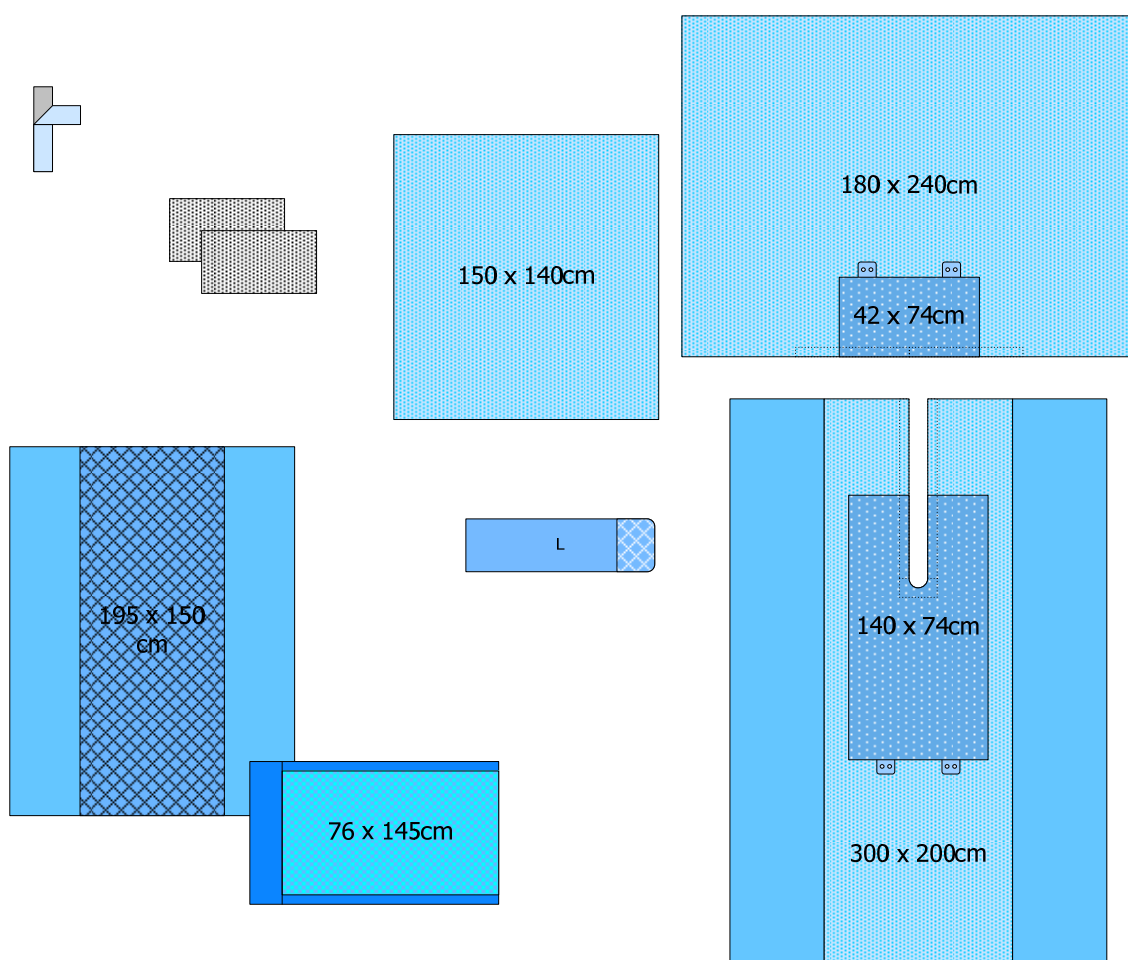

● SMS
 ● PSB3030
 ● PE Film
 ● PE Film
 ● PSB Absorberend
 ● PSB Absorberend medium

11002EG Orthopedie Splitlaken pakket

Omschrijving	aantal	Component nummer	afmetingen
Bovenlaken, met tape	1	1301880	180 x 240 cm
Splitlaken, split 10 x 100 cm, met tape	1	1301920	300 x 200 cm
Laken	1	1301921	150 x 140 cm
Instrumentenveld	1	1306755	195 x 150 cm
Overzet-tafelsloop medium duty	1	1301901	76 x 145 cm
Stockinette L	1	1301922	122 x 35 cm
Tapestrip	1	1301916	10 x 50 cm
Handdoekje	2	1307245	34 x 61 cm

10 pakketten per doos

3.2 Orthopedie splitlaken pakket Prestico®

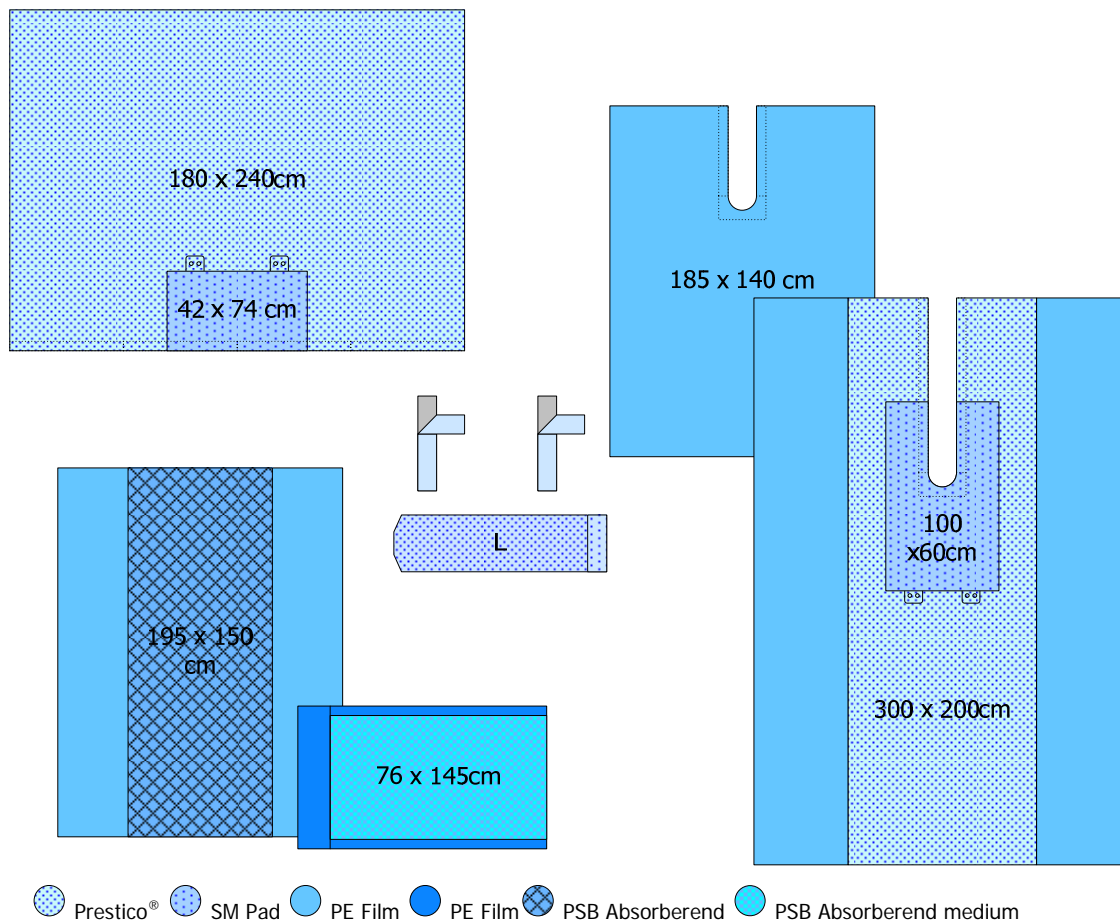

106226AA Orthopedie splitlaken pakket

Omschrijving	aantal	Component nummer	afmetingen
Bovenlaken	1	1302462	180 x 240 cm
Splitlaken PE film, split 15 cm	1	1306954	185 x 140 cm
Splitlaken, split 15 cm	1	1302469	300 x 200 cm
Instrumentenveld	1	1306755	195 x 150 cm
Overzet-tafelsloop medium duty	1	1301901	76 x 145 cm
Stockinette (Large)	1	1301513	30 x 122 cm
Tape strip	2	1302102	10 x 50 cm

10 pakketten per doos

3.3 Extremiten (hand) pakket SMS

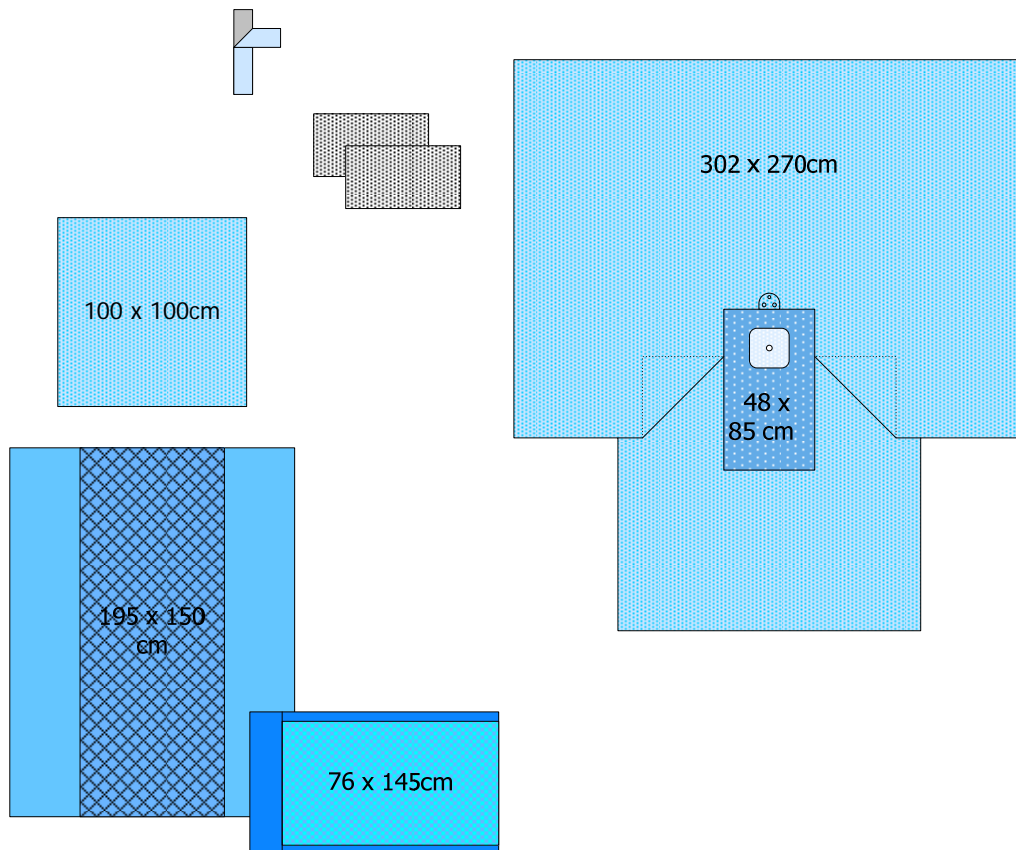

- SMS ● PSB3030 ○ Elastisch materiaal ● PE Film ● PE Film ● PSB Absorberend
- PSB Absorberend medium

11004EG Extremiten (hand) set

Omschrijving	aantal	Component nummer	afmetingen
Hand laken venster Ø 3cm	1	1301926	302 x 270 cm
Laken	1	1301927	100 x 100 cm
Instrumentenveld	1	1306755	195 x 150 cm
Overzet-tafelsloop medium duty	1	1301901	76 x 145 cm
Tapestrip	1	1301916	10 x 50 cm
Handdoekje	2	1307245	34 x 61 cm

16 pakketten per doos

3.4 Extremiteten (voet/been) pakket SMS

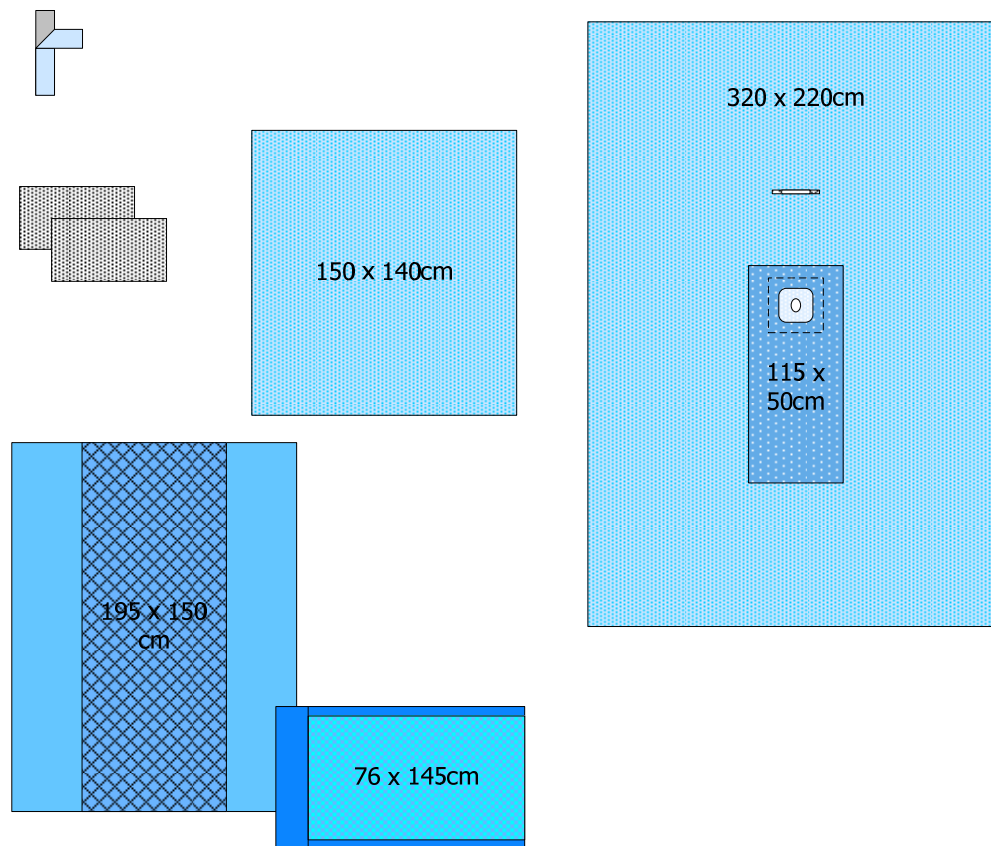

● SMS
 ● PSB3030
 ○ Elastisch Materiaal
 ● PE Film
 ● PE Film
 ● PSB Absorberend
● PSB Absorberend medium

11005EG Extremiteten (voet/been) set

Omschrijving	aantal	Component nummer	afmetingen
Extremiteten laken, Venster 5x7cm	1	1301928	320 x 220 cm
Laken	1	1301921	150 x 140 cm
Instrumentenveld	1	1306755	195 x 150 cm
Overzet-tafelsloop medium duty	1	1301901	76 x 145 cm
Tapestrip	1	1301916	10 x 50 cm
Handdoekje	2	1307245	34 x 61 cm

14 pakketten per doos

3.5 Arthroscopie pakket SMS

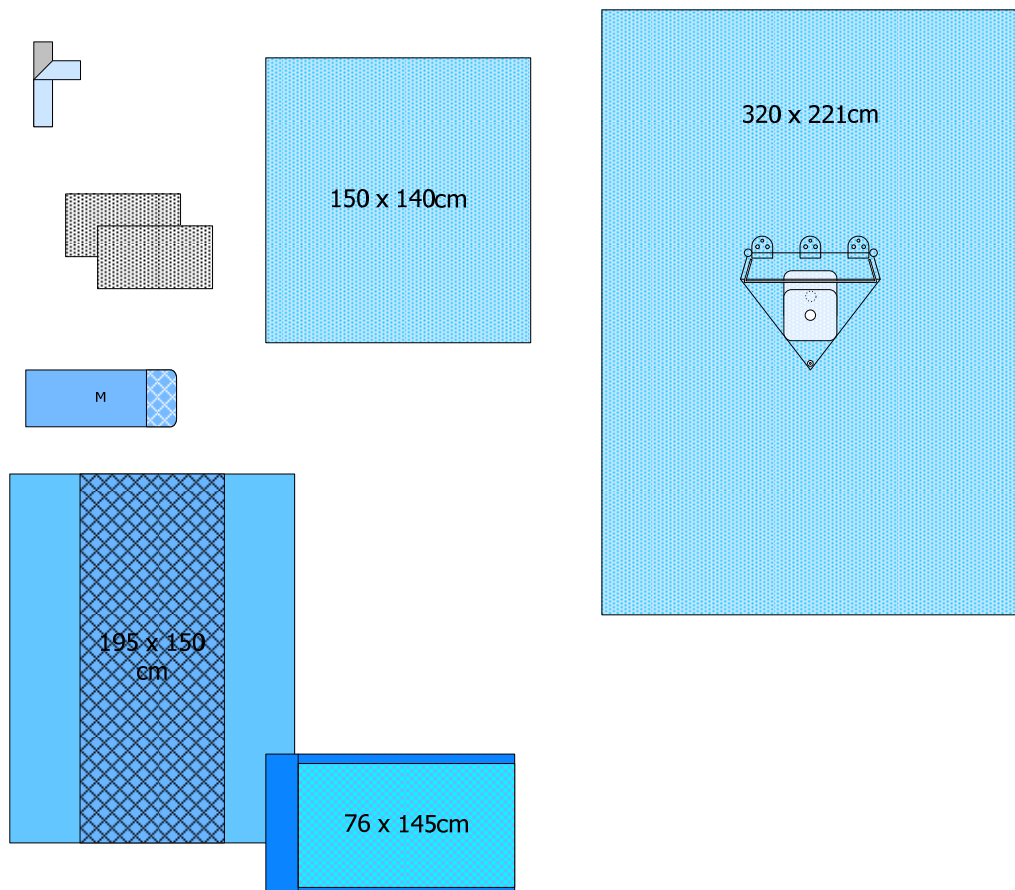

● SMS
 ● Elastisch materiaal
 ● PE Film
 ● PE Film
 ● PSB Absorberend
 ● PSB medium Absorberend

11006EG Arthroscopie set SMS

Omschrijving	aantal	Component nummer	afmetingen
Arthroscopielaken met vloeistofopvangzak, Venster Ø 6cm	1	1301929	320 x 221 cm
Laken	1	1301921	150 x 140 cm
Stockinette M	1	1301930	122 x 30 cm
Instrumentenveld	1	1306755	195 x 150 cm
Overzet-tafelsloop medium duty	1	1301901	76 x 145 cm
Tapestrip	1	1301916	10 x 50 cm
Handdoekje	2	1307245	34 x 61 cm

14 pakketten per doos

3.6 Extremiteten lakens

3.6.1 Extremitetenlakens met Elastisch Venster, SMS

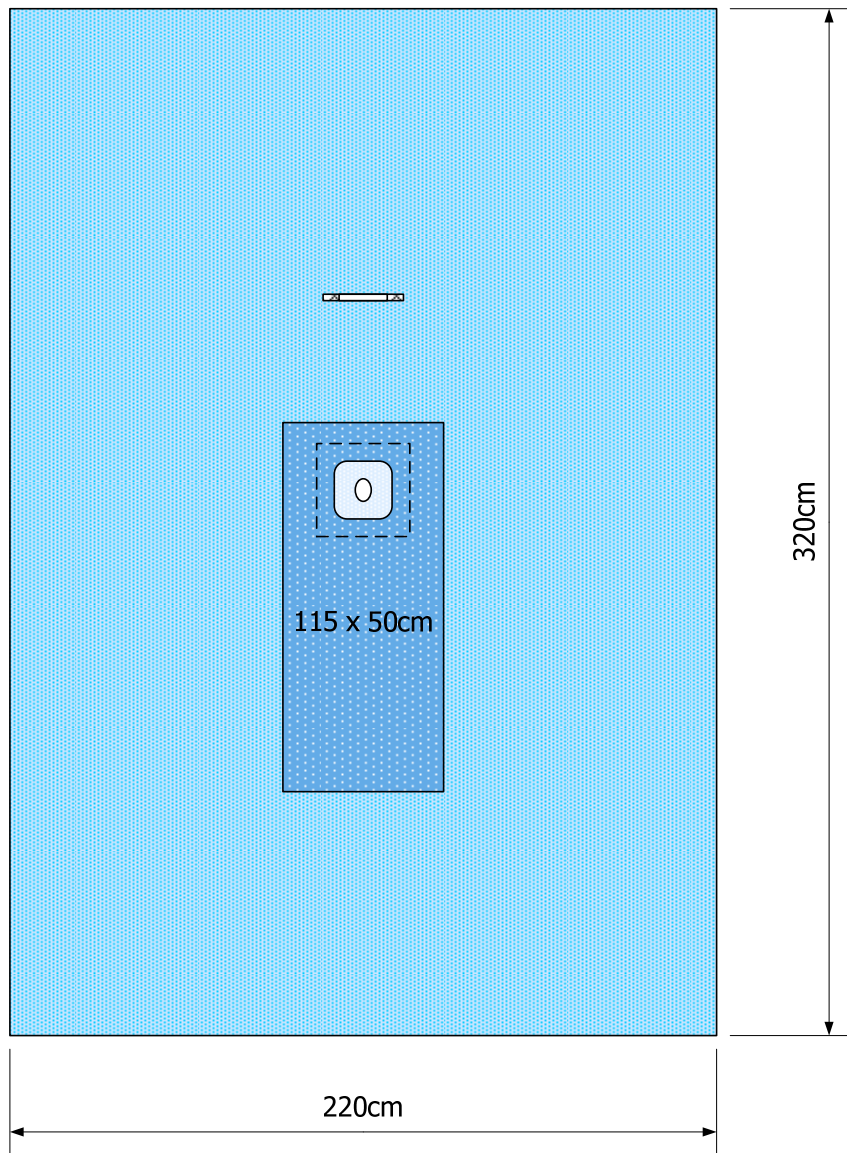

● SMS
 ● PSB3030
 ○ Elastisch Materiaal

Materiaal	Afmeting	Component nummer	Bestel nummer steriel	Aantal per doos	Bestel nummer steriel	Aantal per doos
SMS	320 x 220 cm	1301928	106227AA	Standaard verpakking	11055EG	Eco verpakking 22
Elastisch Venster met ovaal Venster van 5 x 7 cm						
Velcro 25 cm						

3.6.2 Extremiteten laken met Elastisch Venster, Prestico®

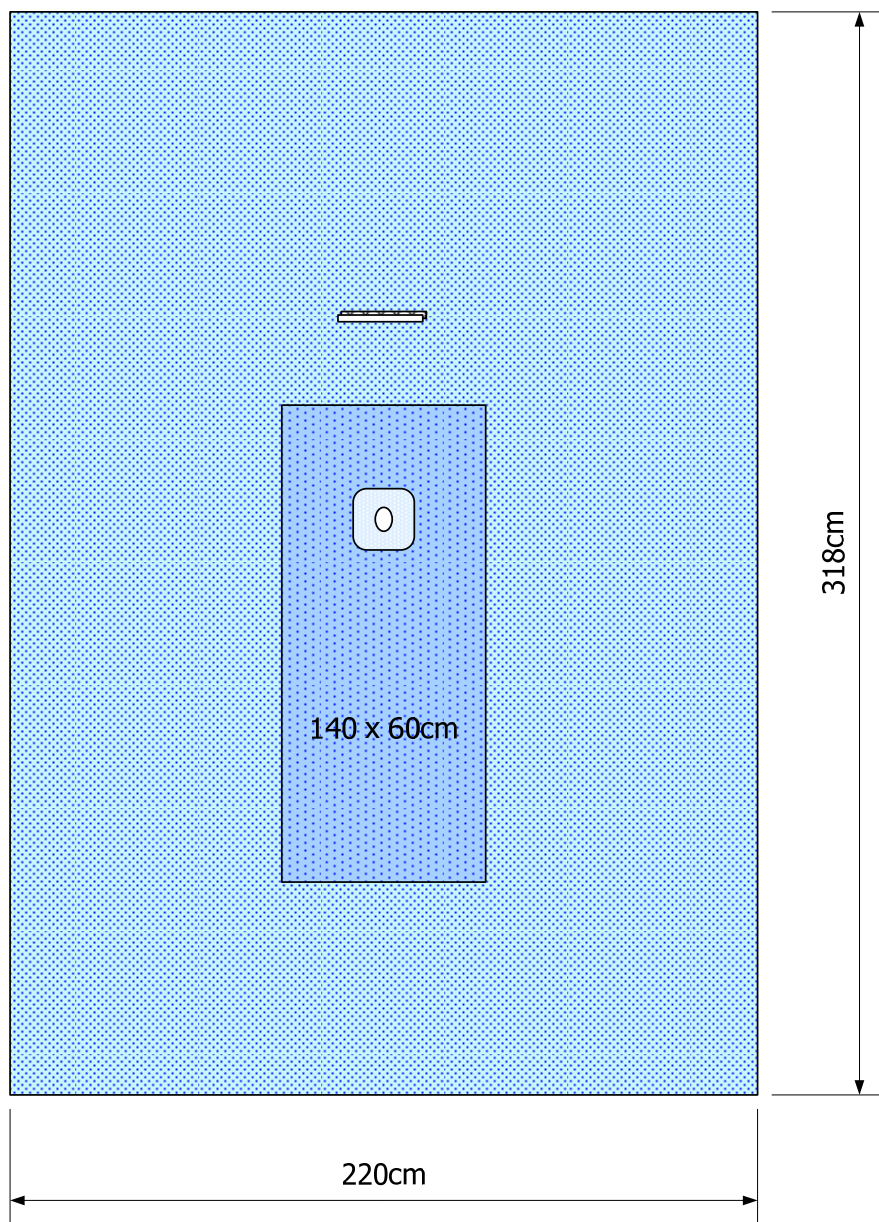

 Prestico®
  SM Pad
  Elastisch materiaal

Materiaal	Afmeting	Component nummer	Bestel nummer steriel	Aantal per doos	Bestel nummer steriel	Aantal per doos
Prestico®	318 x 220 cm	1302465	106228AA	Standaard verpakking	Eco verpakking	
Elastisch Venster met ovaal Venster van 5 x 7 cm						
Velcro 25 cm						

3.6.3 Extremitätenlaken met Elastisch Venster, 3-laags

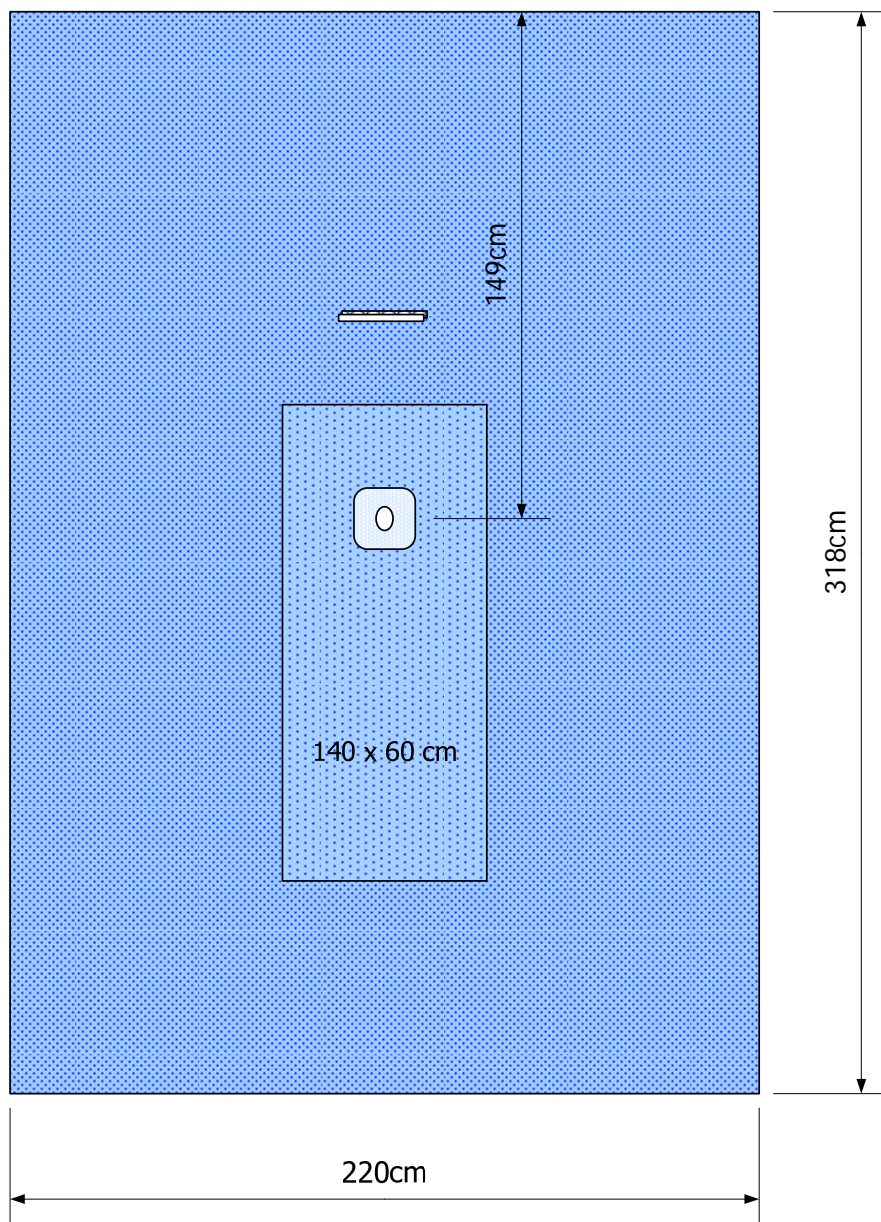

3-laags Absorberend Materiaal
 3-laags
 Elastisch materiaal

Materiaal	Afmeting	Component nummer	Bestel nummer steriel	Aantal per doos	Bestel nummer steriel	Aantal per doos
3-laags	318 x 220 cm	1301977	103697AA	10		
			Standaard verpakking		Eco verpakking	
Elastisch Venster met ovaal Venster van 5 x 7 cm						
Velcro 25 cm						

3.6.4 Extremitätenlaken hand-voet met Elastisch Venster, 3-laags

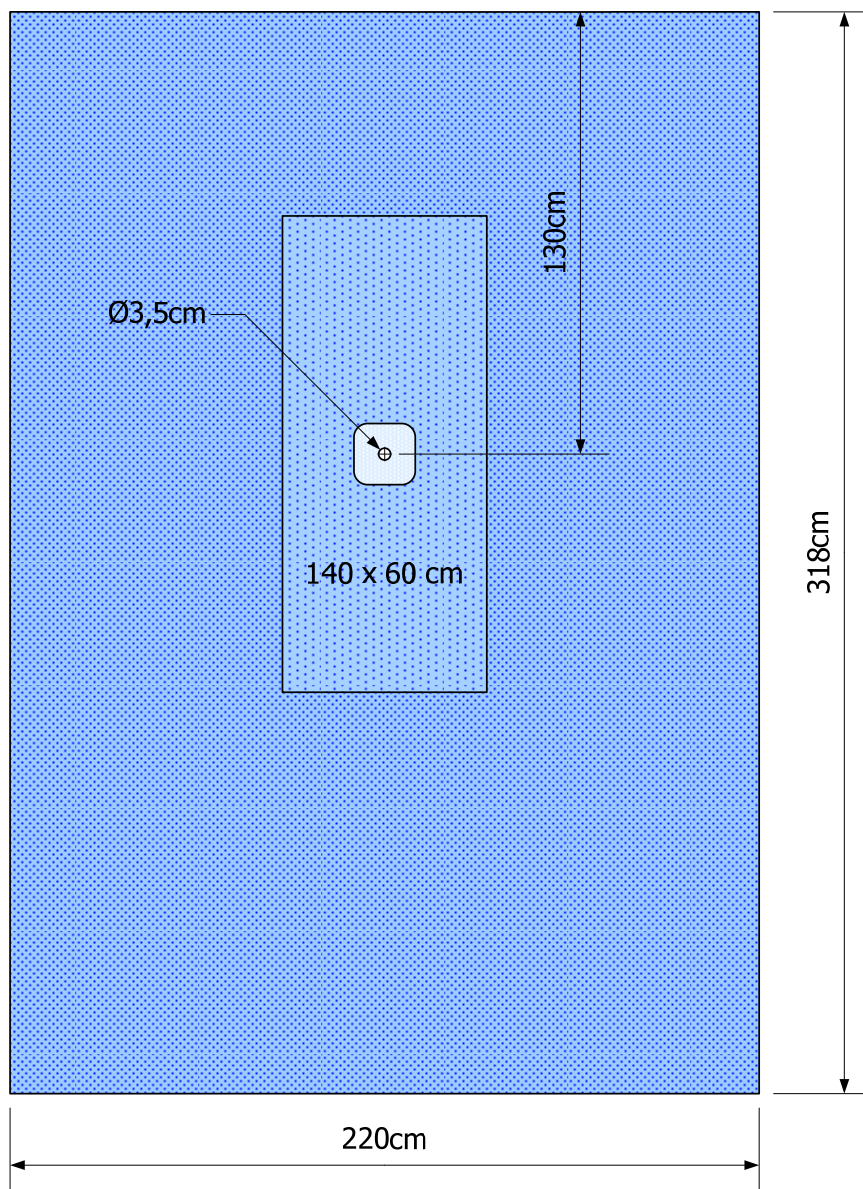

3-laags
 Absorberend Materiaal
 Elastisch materiaal

Materiaal	Afmeting	Component nummer	Bestel nummer steriel	Aantal per doos	Bestel nummer steriel	Aantal per doos
3-laags	318 x 220 cm	1302064	104556AA	10		

Elastisch Venster met Venster Ø 3,5cm

3.6.5 Bilateraal extremitetenlaken met twee elastische vensters SMS

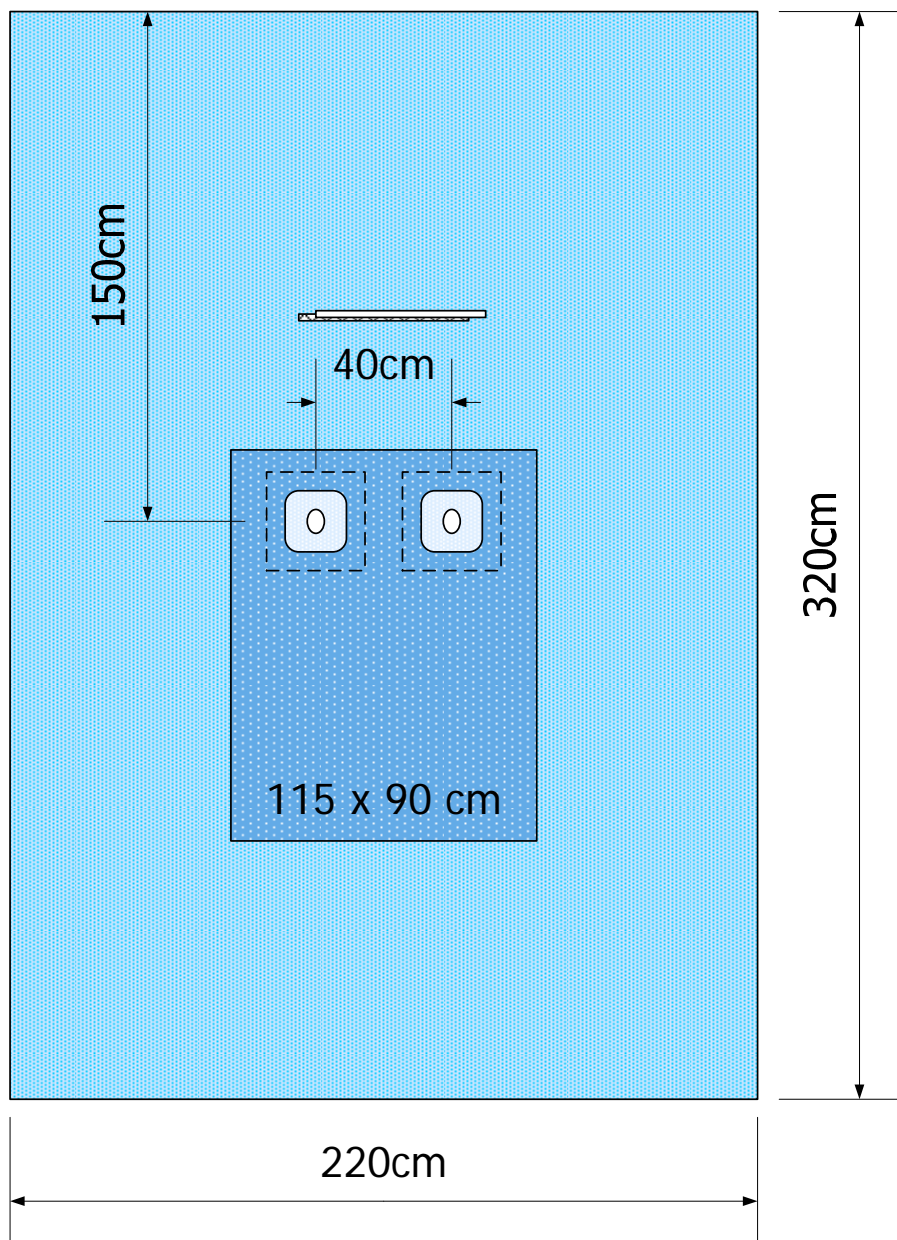





● SMS
 ● PSB3030
 ○ Elastisch materiaal

Materiaal	Afmeting	Component nummer	Bestel nummer steriel	Aantal per doos	Bestel nummer steriel	Aantal per doos
			Standaard verpakking		Eco verpakking	
SMS	320 x 220 cm	1302234	106229AA		11057EG	18

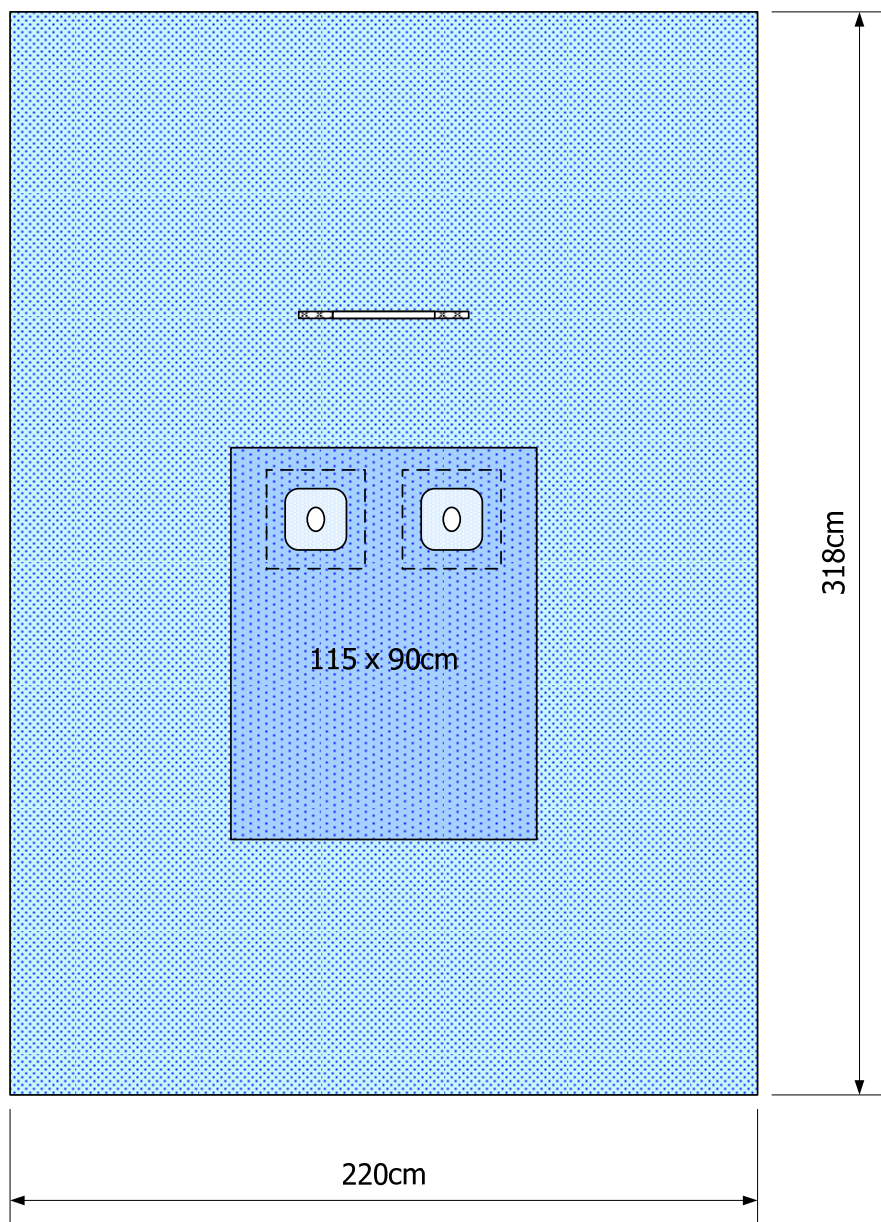
Twee elastische vensters met ovale vensters 7 x 5 cm
 Velcro tape, 50 cm bevestigd op laken en 30 cm los

3.6.6 Bilateraal extremiteiten laken met twee elastische vensters Prestico®







 Prestico®
  SM Pad
  Elastisch materiaal

Materiaal	Afmeting	Component nummer	Bestel nummer steriel	Aantal per doos	Bestel nummer steriel	Aantal per doos
Prestico®	318 x 220 cm	1302489	106232AA			
			Standaard verpakking		Eco verpakking	

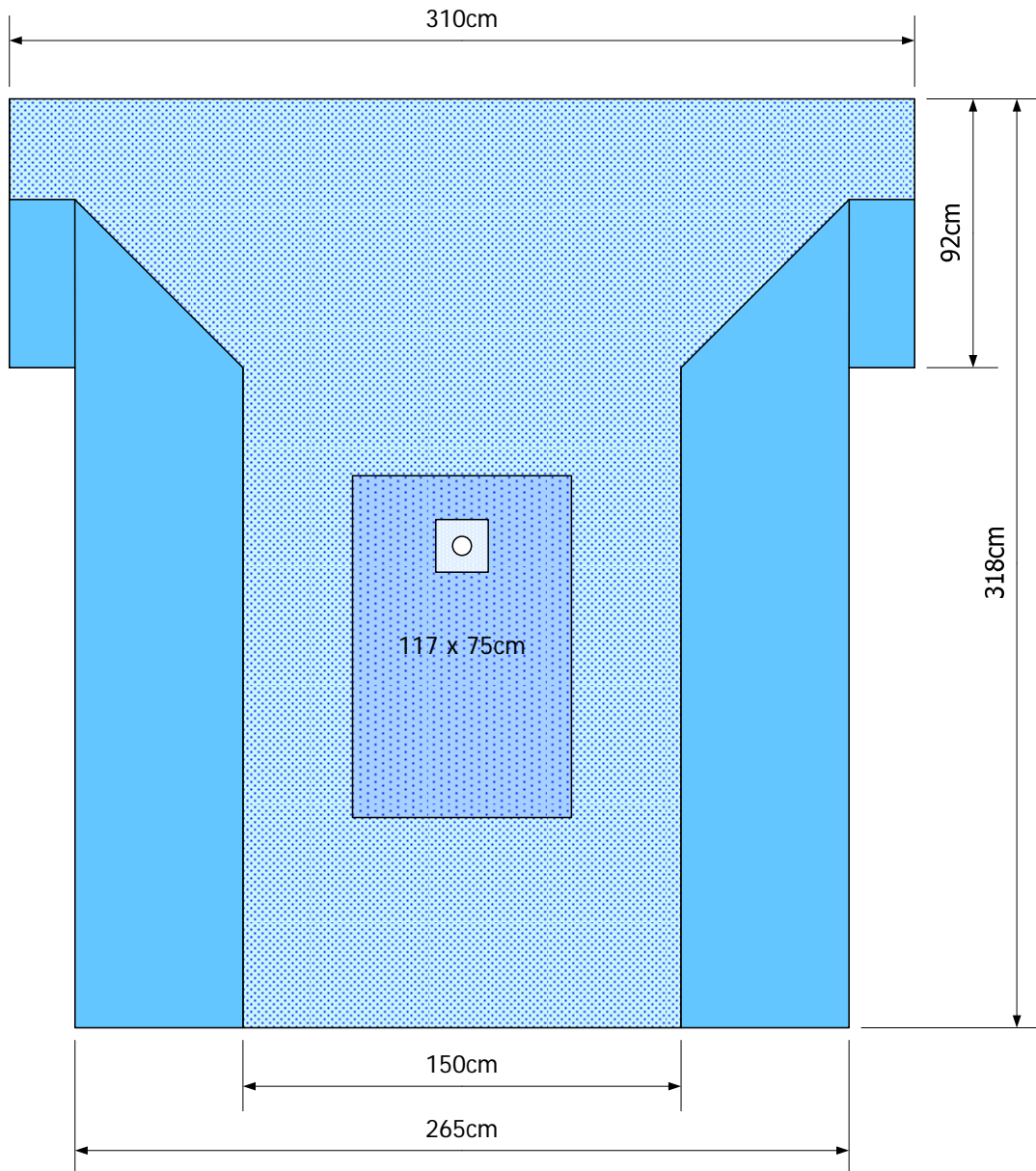
Twee elastische vensters met ovale vensters van 7 x 5 cm
 Velcro tape, 50 cm bevestigd op laken en 30 cm los

3.6.7 Extremiteten laken met Elastisch Venster en Armsteun bedekkingen Prestico®



 Prestico®
  SM Pad
  Polyethyleen film
  Elastisch materiaal

Materiaal	Afmeting	Component nummer	Bestel nummer steriel	Aantal per doos	Bestel nummer steriel	Aantal per doos
Prestico®	318 x 265/310 cm	1302545	106234AA	Standaard verpakking	Eco verpakking	

Elastisch venster 18 x 18 cm met venster van Ø 6,5 cm
 Armsteun bedekkingen

3.6.8 Extremiteten laken met Elastisch Venster en Armsteun bedekkingen 3-laags

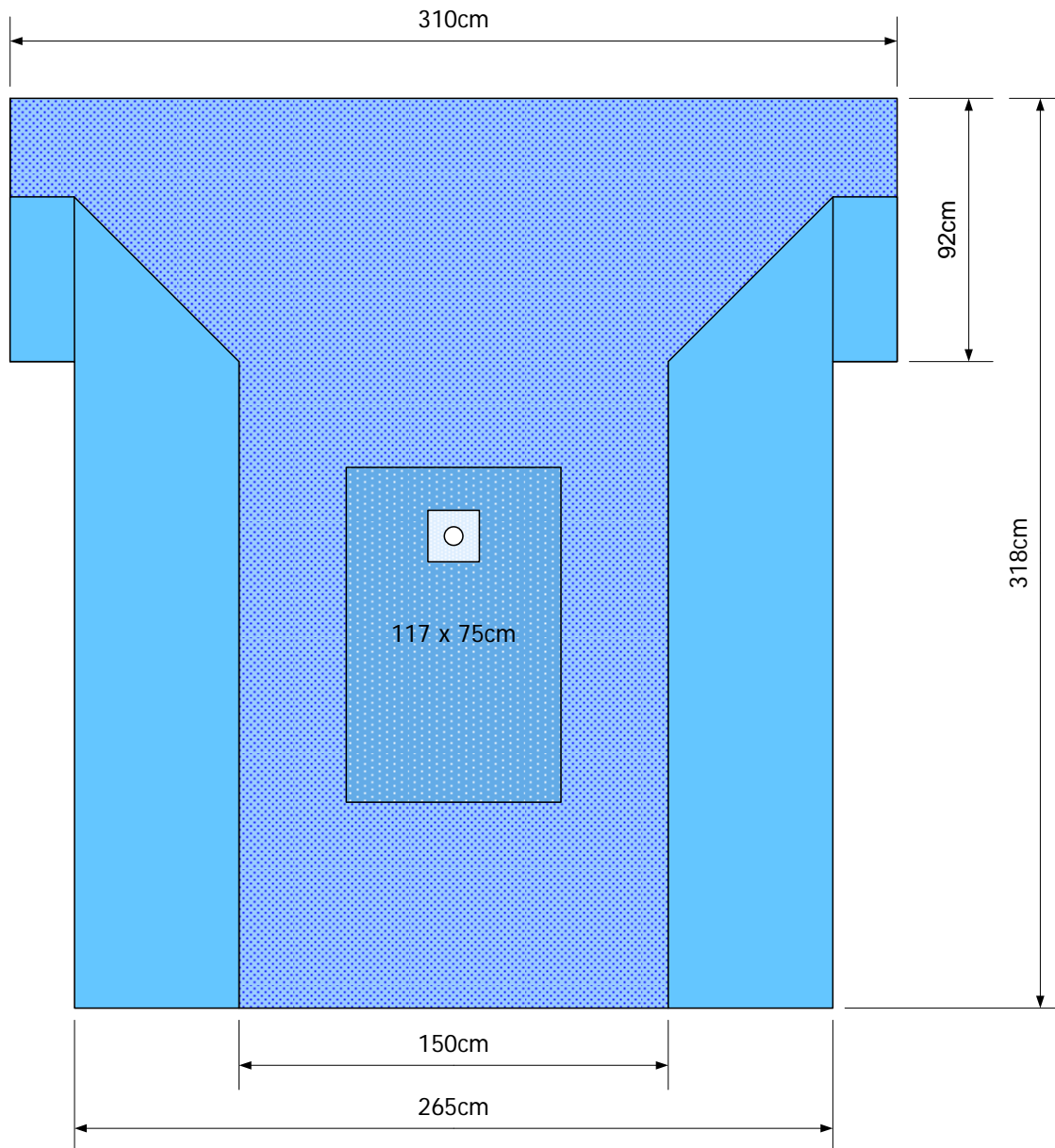

3-laags 60 gsm
 PSB3030
 Polyethyleen film
 Elastisch materiaal

Materiaal	Afmeting	Component nummer	Bestel nummer steriel	Aantal per doos	Bestel nummer steriel	Aantal per doos
3-laags	318 x 265/310 cm	1302542	106168AA	Standaard verpakking	Eco verpakking	

Elastisch venster 18 x 18 cm met venster van Ø 6,5 cm
 Armsteun bedekkingen

3.6.9 Arthroscopie laken met vloeistofopvangzak 2-laags

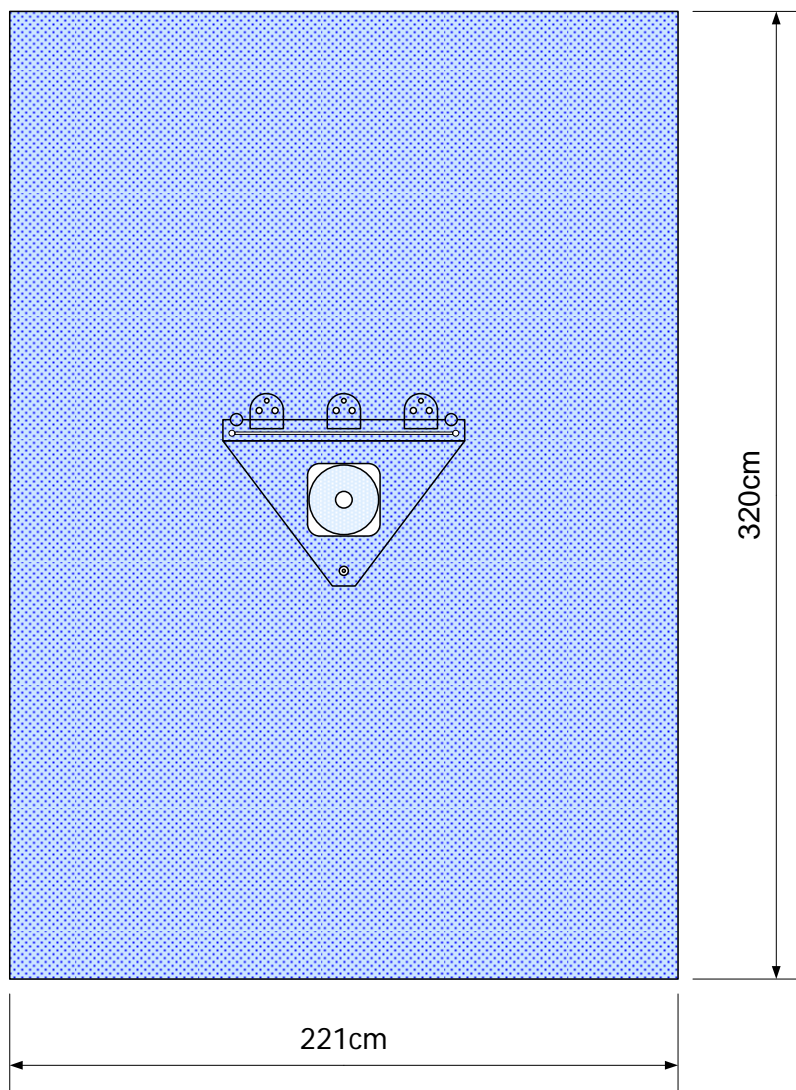

2-laags
 Elastisch materiaal

Materiaal	Afmeting	Component nummer	Bestel nummer steriel	Aantal per doos	Bestel nummer steriel	Aantal per doos
2-laags	320 x 221 cm	1306997	103484AA	10		
			Standaard verpakking		Eco verpakking	

1 Vloeistofopvangzak

2 Elastische venster Ø 5,5 cm

3 Slangenhouders

3.6.10 Arthroscopie laken met vloeistofopvangzak SMS

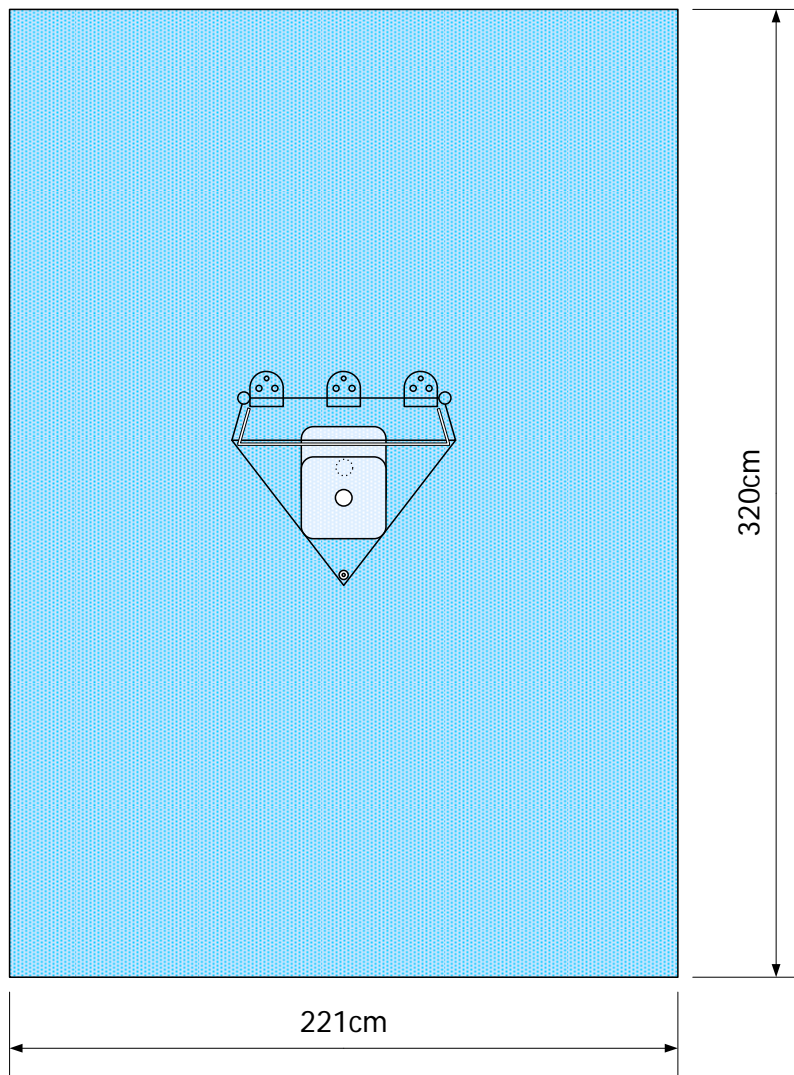

● SMS
 ○ Elastisch materiaal

Materiaal	Afmeting	Component nummer	Bestel nummer steriel	Aantal per doos	Bestel nummer steriel	Aantal per doos
SMS	320 x 221 cm	1301929	104362AA	Standaard verpakking	11056EG	Eco verpakking 19
Vloeistofopvangzak						
Elastisch Venster Ø 6 cm						
3 Slangenhouders						

3.6.11 Schouderlaken

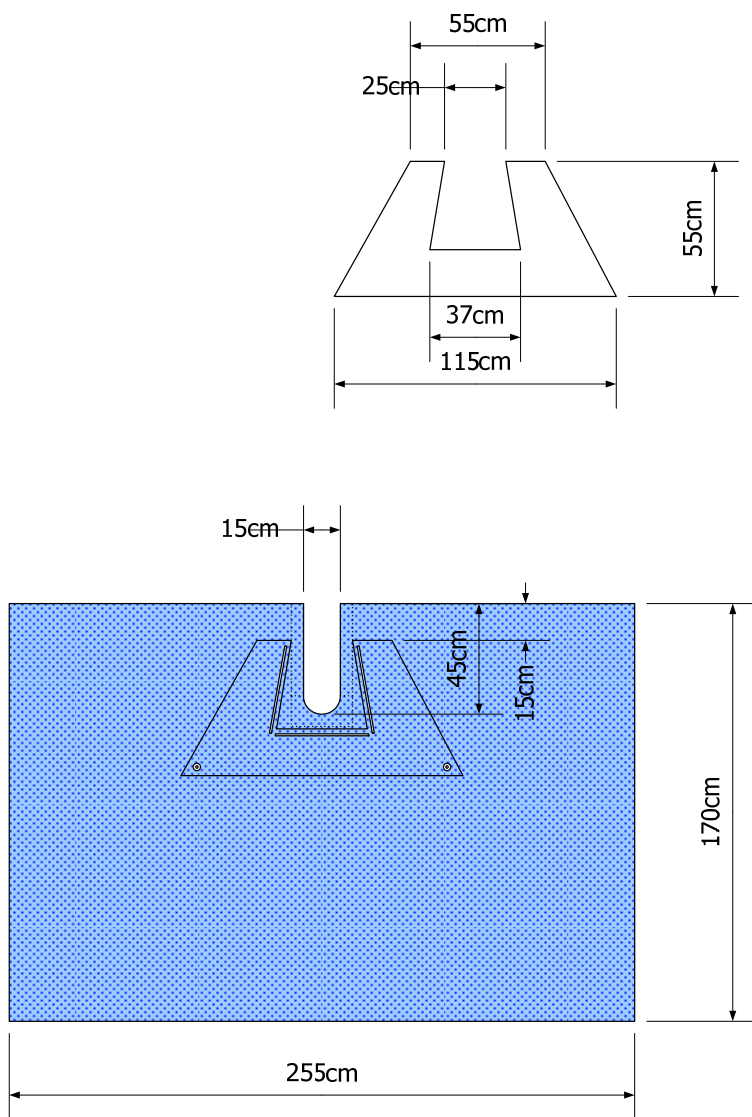

 3-laags 60 gsm

Materiaal	Afmeting	Component nummer	Bestel nummer steriel	Aantal per doos	Bestel nummer steriel	Aantal per doos
				Standaard verpakking	Eco verpakking	
3-laags 60 gsm	170 x 255cm	1302544				
Vloeistofopvangzak						
Tape 5cm						

3.6.12 Beach chair laken SMS

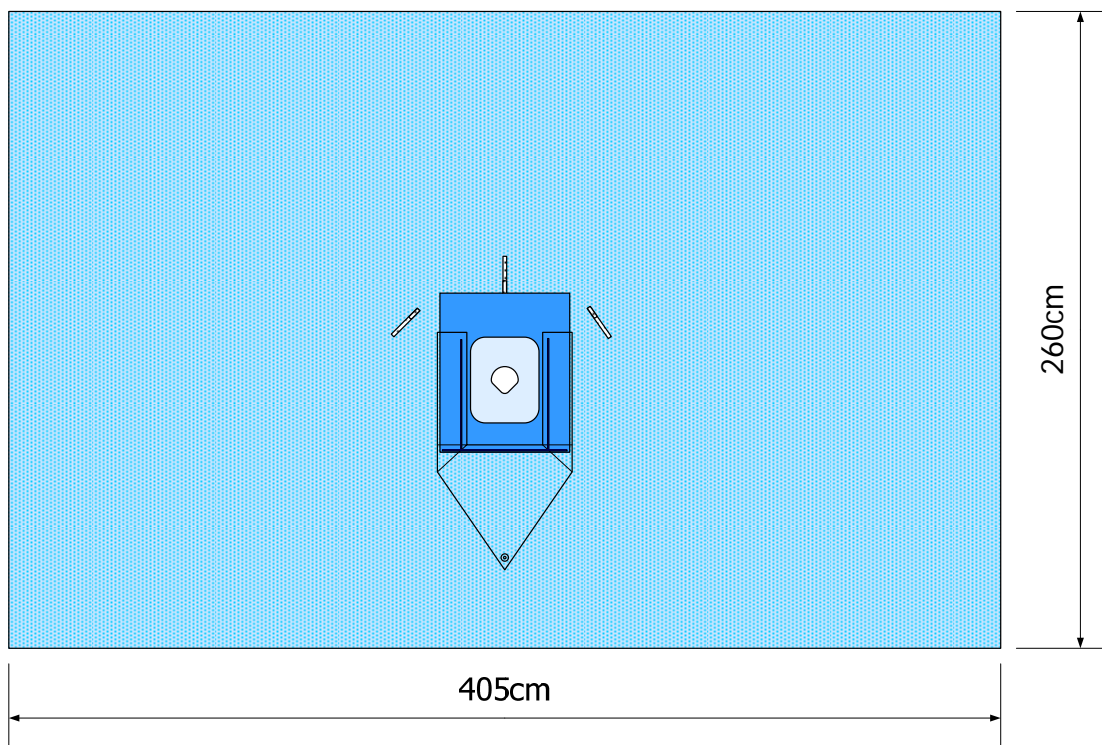

● SMS
 ○ Elastisch materiaal
 ● PE-Film versterking

Materiaal	Afmeting	Component nummer	Bestel nummer steriel	Aantal per doos	Bestel nummer steriel	Aantal per doos
SMS	260 x 405 cm	1307156	Standaard verpakking		Eco verpakking	

Vloeistofopvangzak met ventiel en flexwires

3 Velcro Slangenhouders

3 stukken of tape op de achterkant (18x5cm) op het Elastisch materiaal

3.6.13 Beach chair laken 3-laags

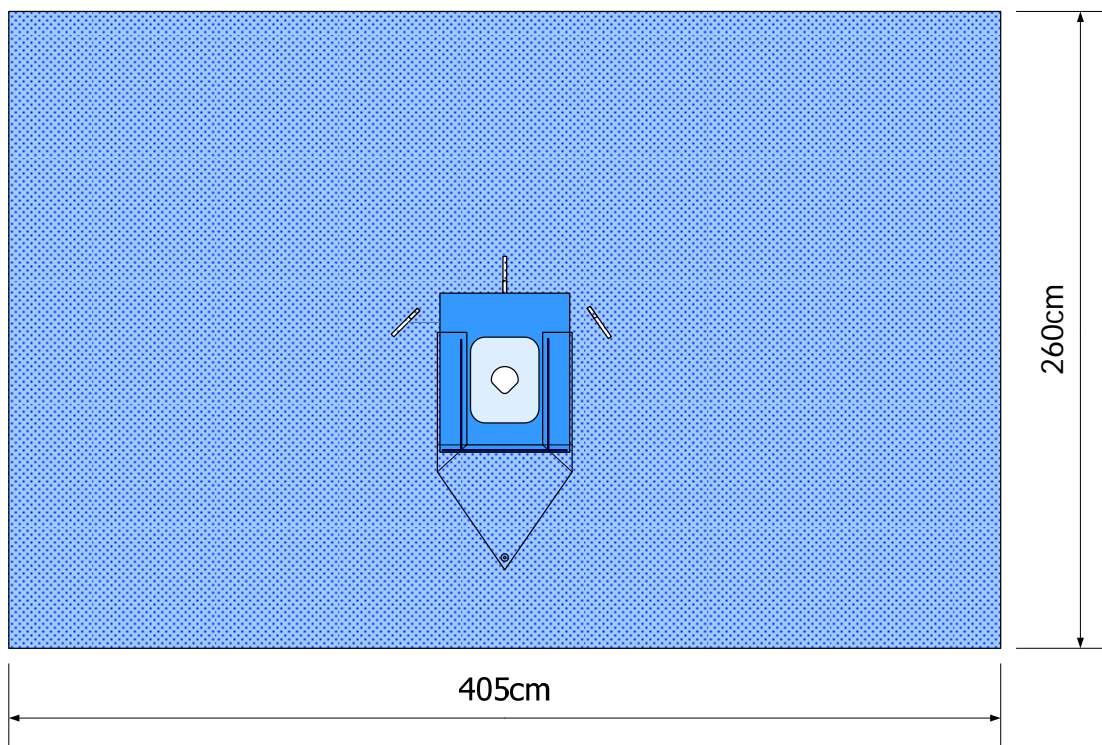

3-laags
 Elastisch materiaal
 PE-Film versterking

Materiaal	Afmeting	Component nummer	Bestel nummer steriel	Aantal per doos	Bestel nummer steriel	Aantal per doos
3-laags	260 x 405cm	1302640	Standaard verpakking		Eco verpakking	

Vloeistofopvangzak met ventiel en flexwires

3 Velcro Slangenhouders

3 stukken of tape op de achterkant (18x5cm) op het Elastisch materiaal

3.6.14 Heuplaken met vloeistofopvangzak en Armsteun bedekkingen

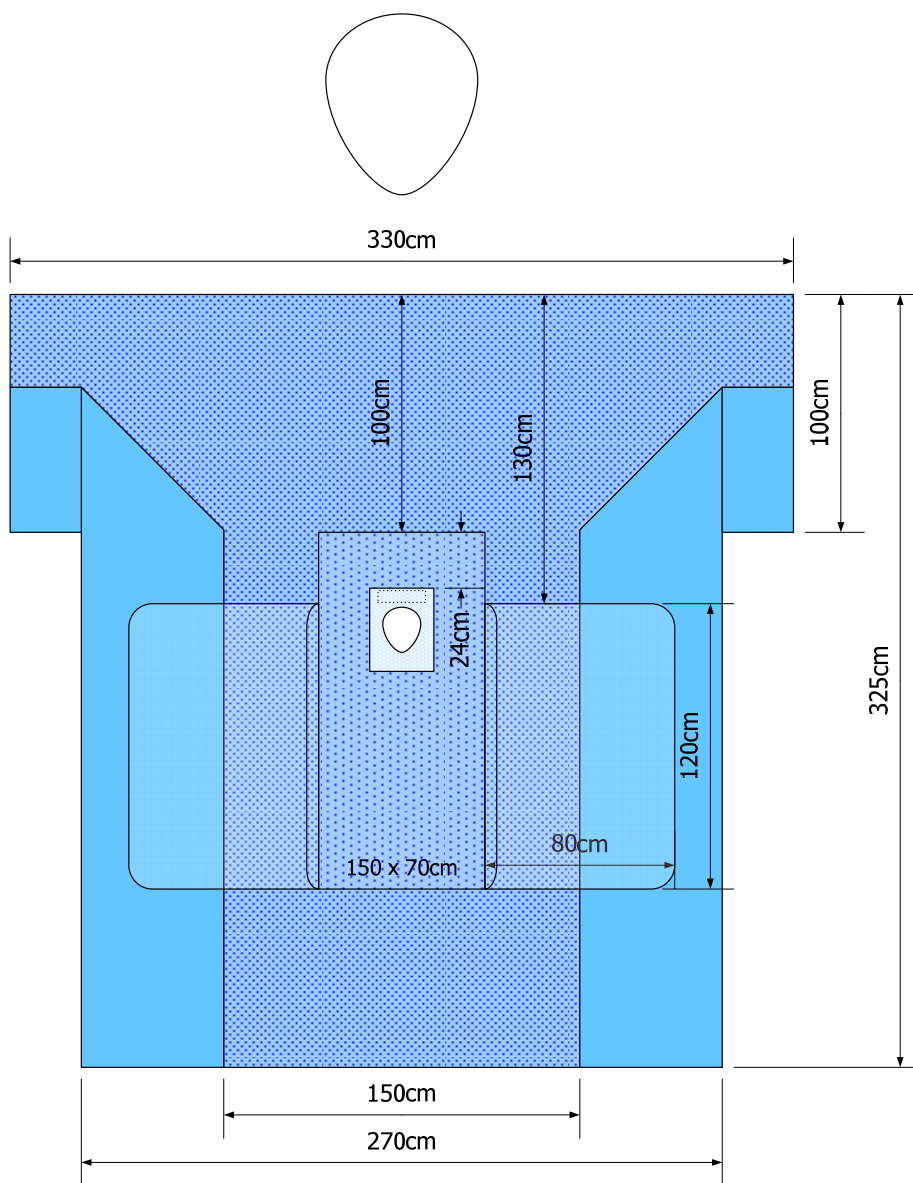

3-laags
 PE-Film
 Absorberend materiaal
 Elastisch materiaal

Materiaal	Afmeting	Component nummer	Bestel nummer	Aantal per doos	Bestel nummer	Aantal per doos
			steriel		steriel	
			Standaard verpakking		Eco verpakking	
3-laags	325 x 270/330 cm	1302275	105762AA			
2 vloeistofopvangzakken						
Ovaal Elastisch Venster van 16 x 19 cm						
Armsteun bedekkingen						
Tape strip 5 x 20 cm						

3.6.15 Handlaken SMS

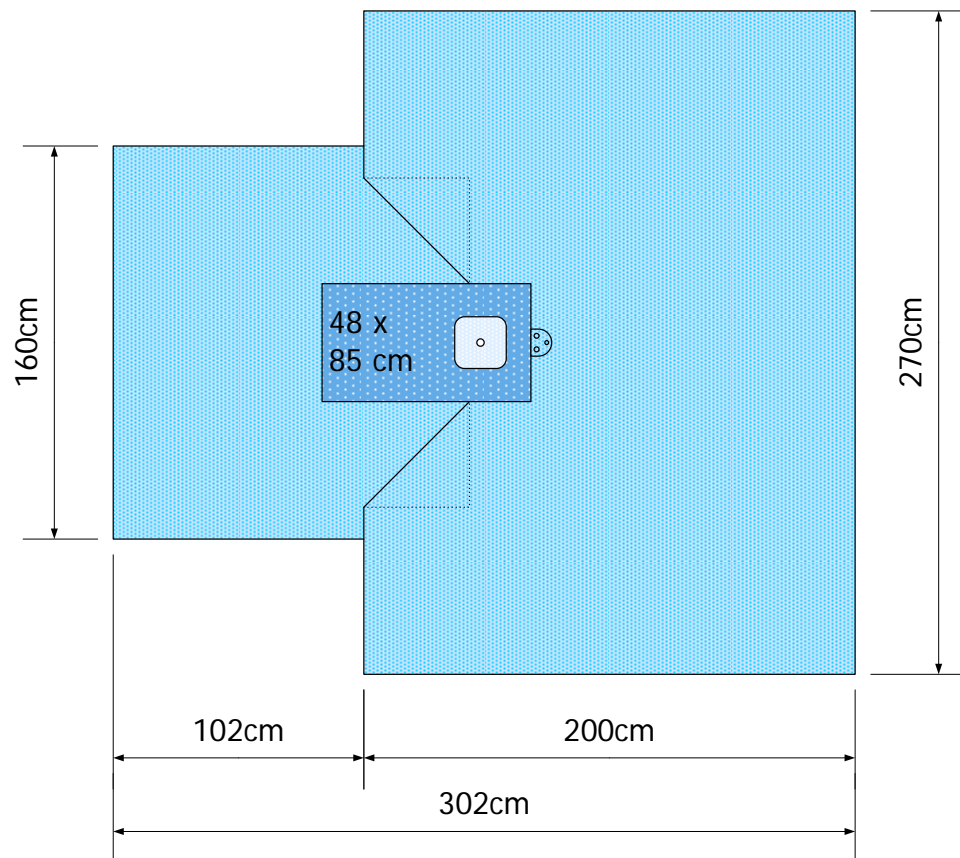



● SMS
 ● PSB3030
 ○ Elastisch materiaal

Materiaal	Afmeting	Component nummer	Bestel nummer	Aantal	Bestel nummer	Aantal
			steriel	per doos	steriel	per doos
			Standaard verpakking		Eco verpakking	
SMS	160/270 x 302cm	1301926	106236AA		11054EG	18
Venster Ø 3 cm						

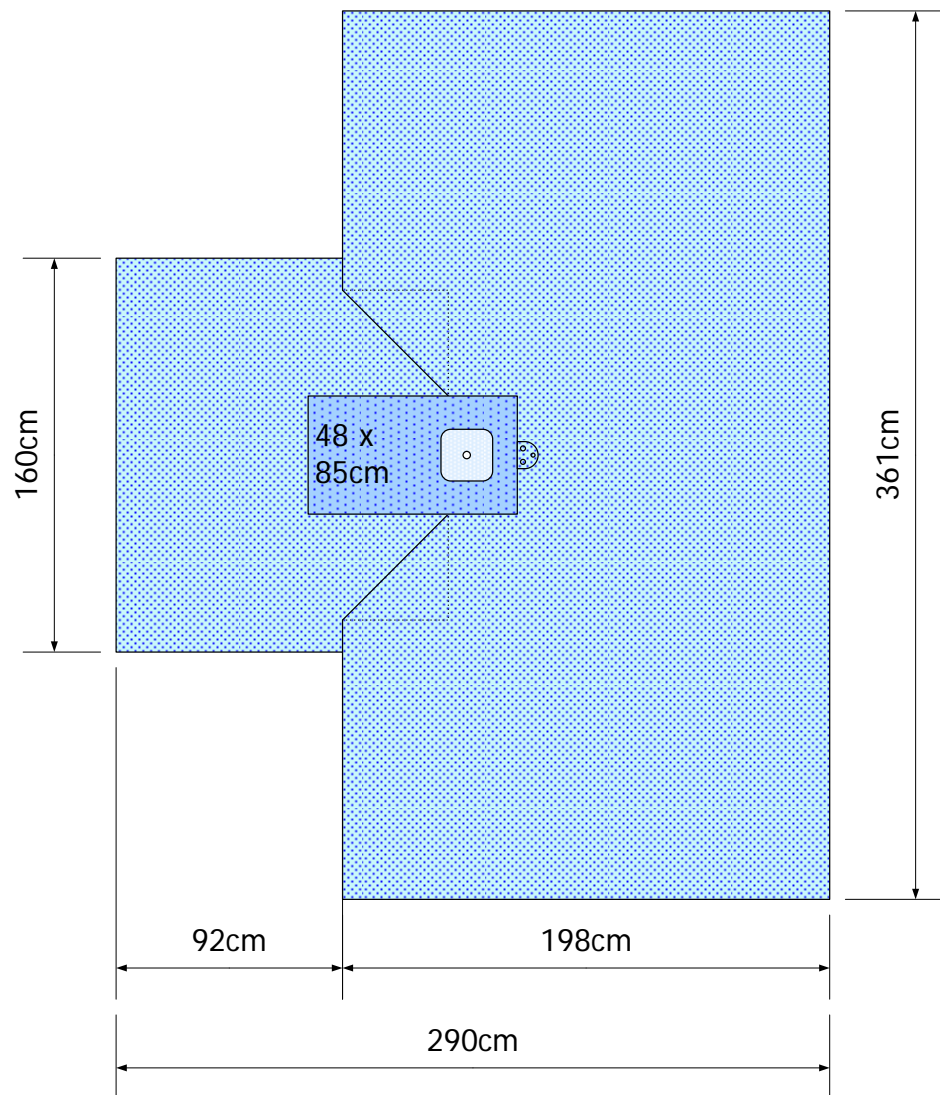
3.6.16 Handlaken Prestico®



 Prestico®
  SM Pad
  Elastisch materiaal

Materiaal	Afmeting	Component nummer	Bestel nummer steriel	Aantal per doos	Bestel nummer steriel	Aantal per doos
Prestico®	160/361 x 290cm	1302466	106238AA	Standaard verpakking	Eco verpakking	
Venster Ø 3 cm						

3.6.17 Handlaken 3-laags

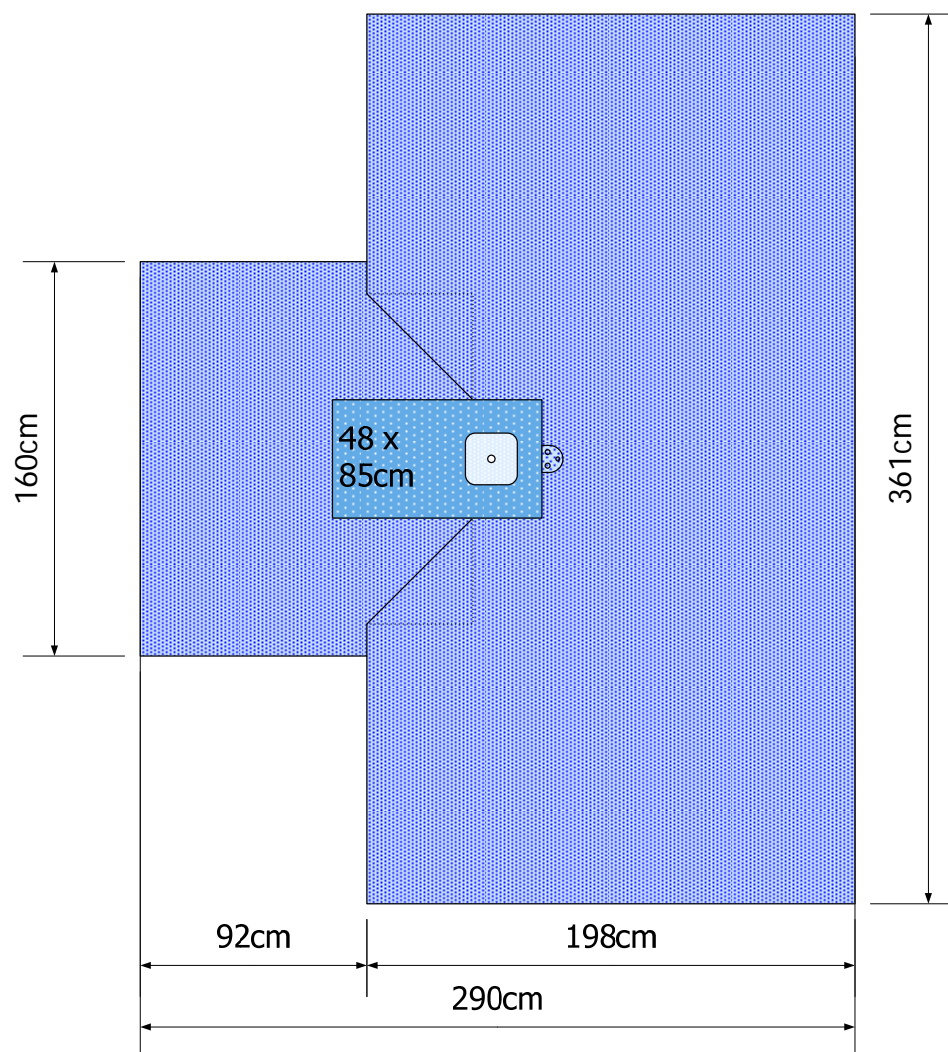

● 3-laags
 ● PSB3030
 ○ Elastisch materiaal

Materiaal	Afmeting	Component nummer	Bestel nummer steriel	Aantal per doos	Bestel nummer steriel	Aantal per doos
			Standaard verpakking		Eco verpakking	
3-laags	160/361 x 290cm	1302641				
Venster Ø 3 cm						

3.7 Vertical isolatie laken

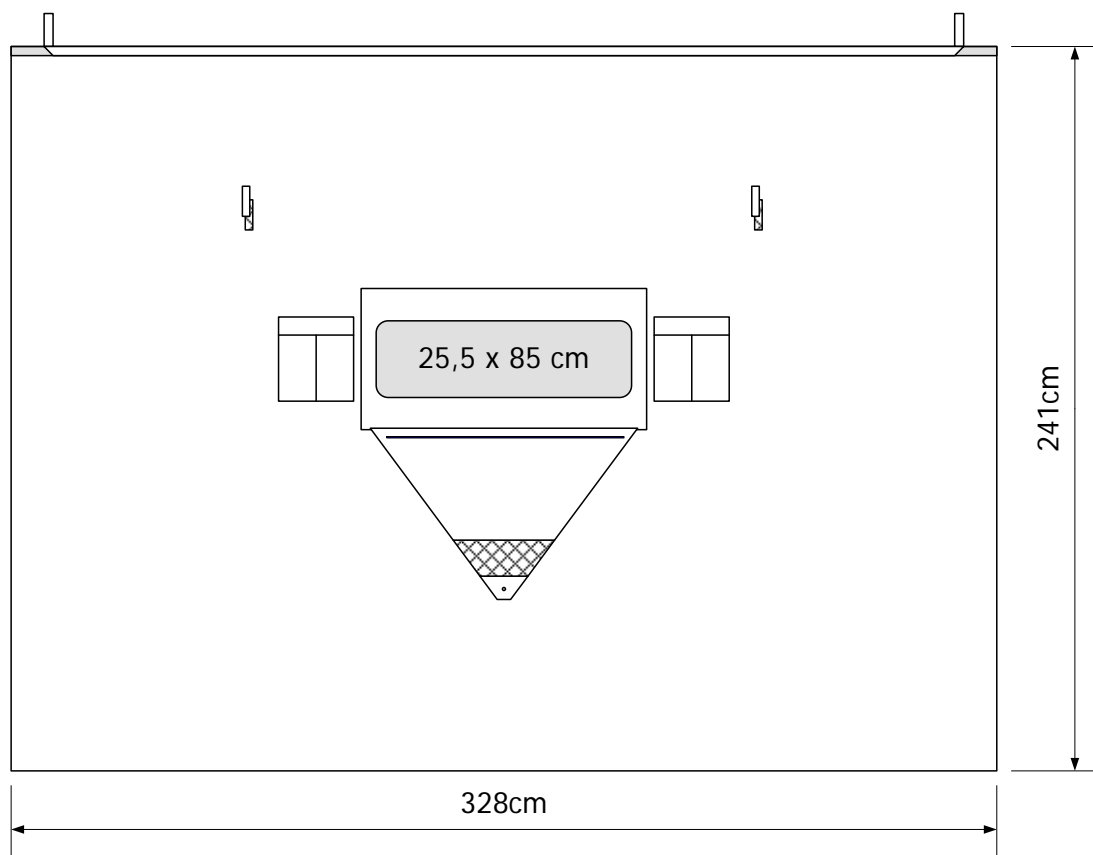

○ Transparant film ○ Incisie film

Materiaal	Afmeting	Component nummer	Bestel nummer steriel	Aantal per doos	Bestel nummer steriel	Aantal per doos
				Standaard verpakking	Eco verpakking	
PE-Film	241 x 328 cm	1302292	105066AA			
Incisie film 25,5 x 85cm						
Tape aan de bovenkant 3 cm breed						
Vloeistofopvangzak, 89 cm breed en 60 cm hoog, met filter en ventiel						
2 x Velcro's						
2 instrumentzakken 25 x 28 cm						

4 Gynaecologie, verloskunde en urologie

4.1 Omega pakket SMS

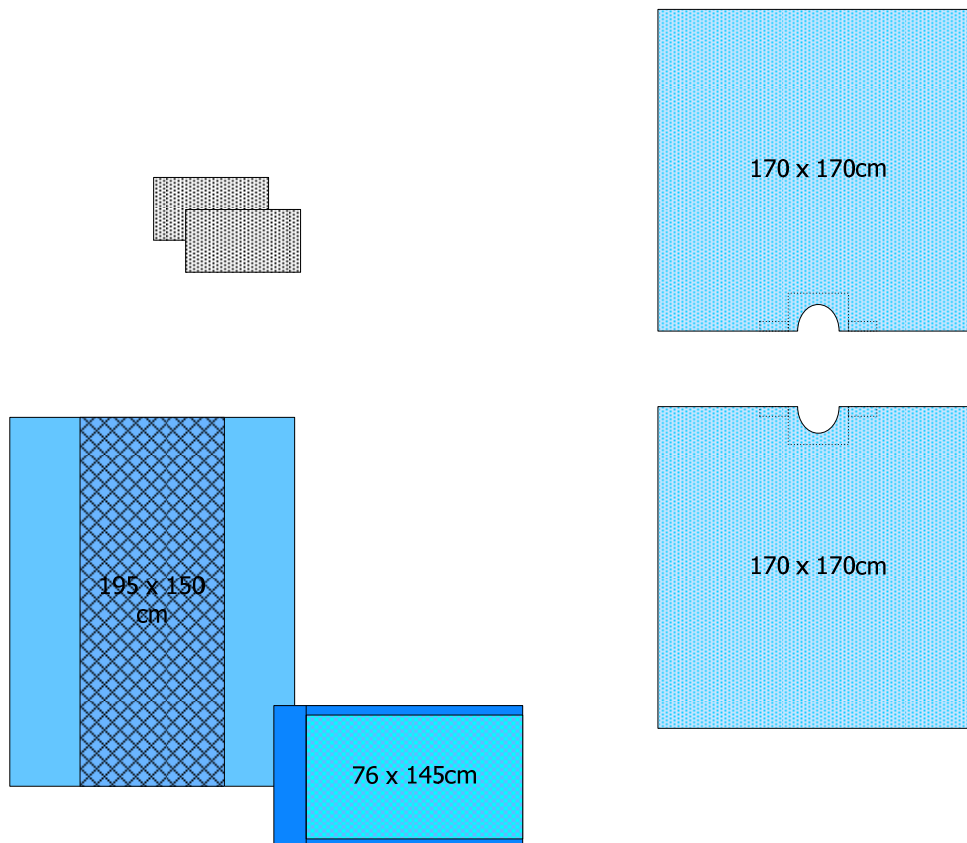

 SMS
  PE Film
  PE Film
  PSB Absorberend
  PSB Absorberend medium

11007EG Omega pakket

Omschrijving	aantal	Component nummer	afmetingen
Omega laken, met tape	2	1301931	170 x 170 cm
Instrumentenveld	1	1306755	195 x 150 cm
Overzet-tafelsloop	1	1301901	76 x 145 cm
Handdoekje	2	1307245	34 x 61 cm

16 pakketten per doos

4.2 Gynaecologie pakket I SMS

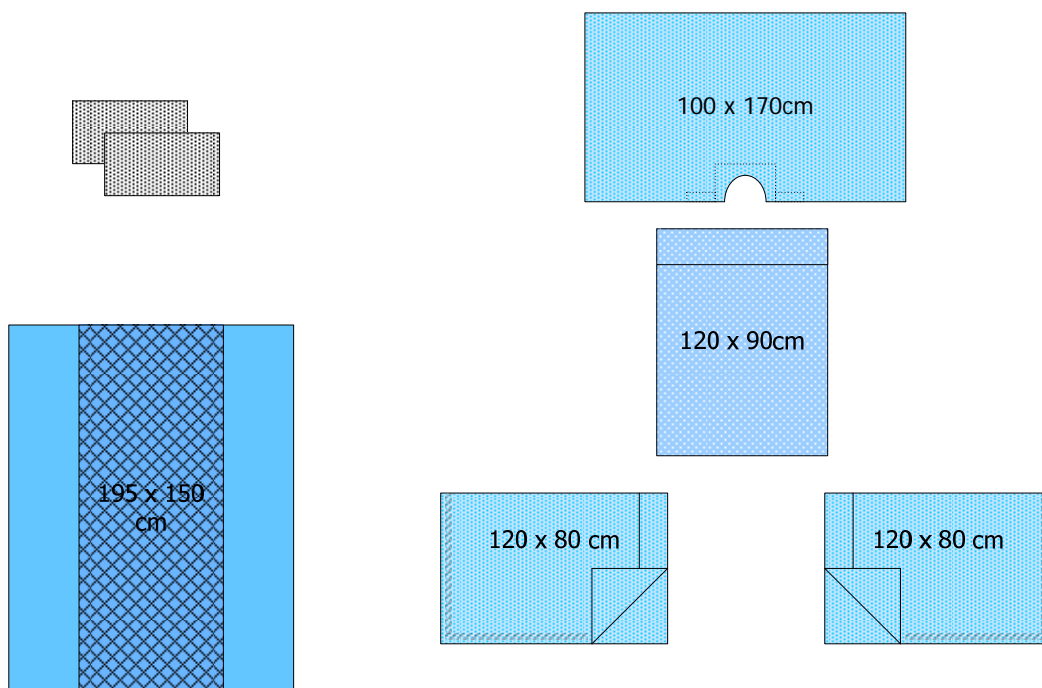

● SMS
 ● 3-laags
 ● PE Film
 ● PSB Absorberend

11003EG Gynaecologie I pakket

Omschrijving	aantal	Component nummer	afmetingen
Omega laken, met tape	1	1301923	100 x 170 cm
Stuitlaken	1	1301924	120 x 90 cm
Beenhoes	2	1301925	120 x 80 cm
Instrumentenveld	1	1306755	195 x 150 cm
Handdoekje	2	1307245	34 x 61 cm

16 pakketten per doos

4.3 Gynaecologie II pakket SMS

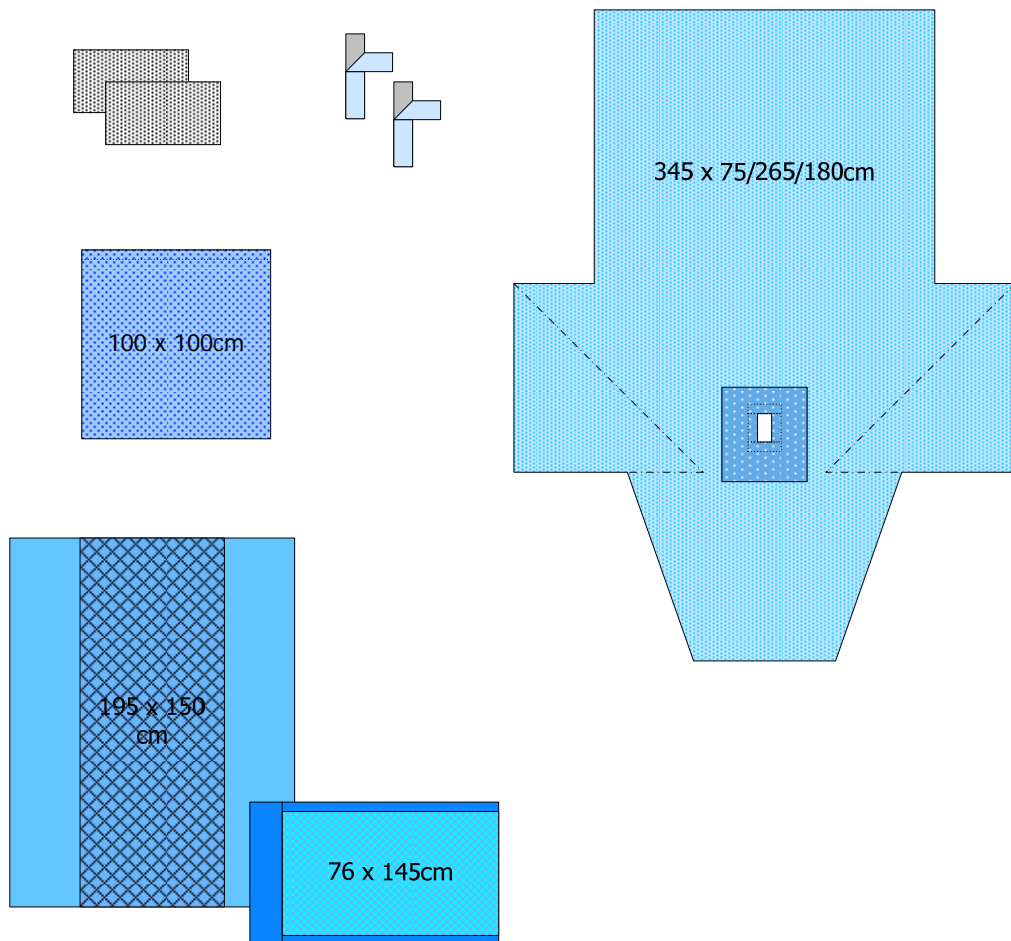

SMS
 PSB3030
 3-laags
 PE Film
 PE Film
 PSB Absorberend
 PSB Absorberend medium

11008EG Gynaecologie II pakket

Omschrijving	aantal	Component nummer	afmetingen
Gyn-Uro laken	1	1301932	345 x 75/265/180cm
Laken, met tape	1	1301933	100 x 100 cm
Instrumentenveld	1	1306755	195 x 150 cm
Overzet-tafelsloop	1	1301901	76 x 145 cm
Tapestrip	2	1301916	10 x 50 cm
Handdoekje	2	1307245	34 x 61 cm

16 pakketten per doos

4.4 C-Sectio pack SMS

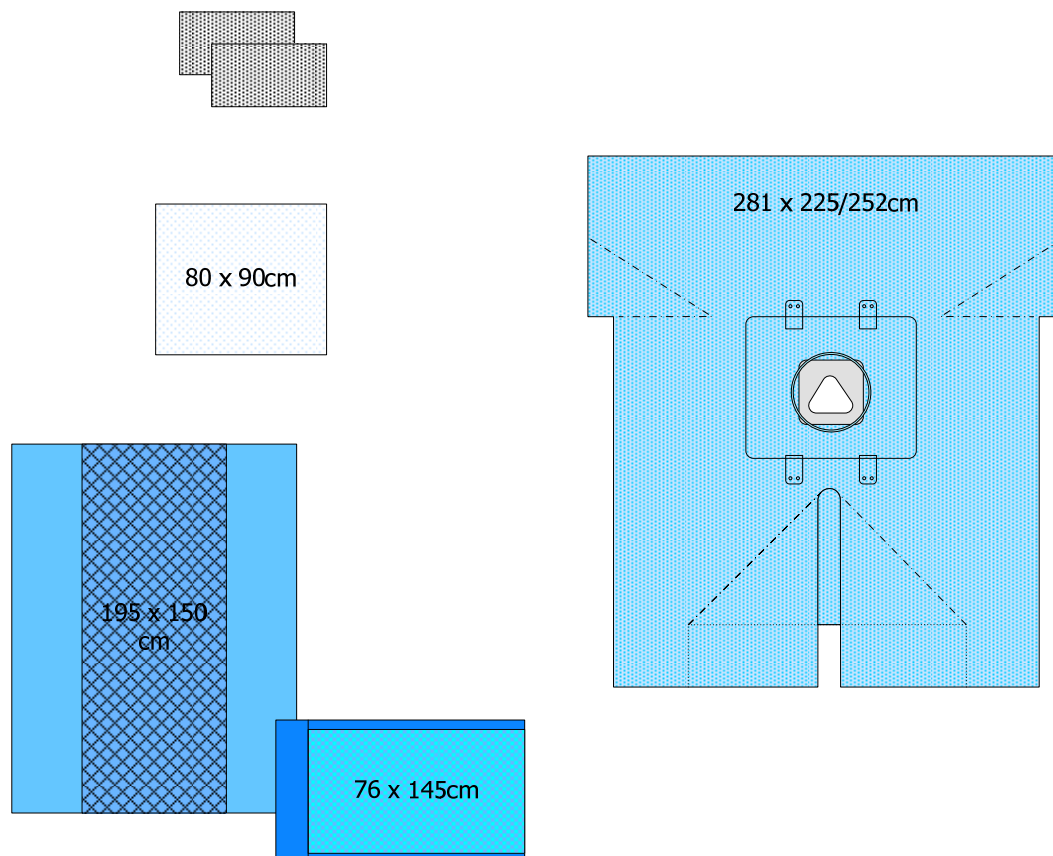

SMS
 PE Film
 PE Film
 PSB Absorberend
 PSB Absorberend medium
 Incisie tape

11009EG C-Sectio set

Omschrijving	aantal	Component nummer	afmetingen
C-Sectio laken met Geïntegreerde beenhoezen, Incisie tape en vloeistofopvangzak	1	1301934	281 x 225/252 cm
Instrumentenveld	1	1306755	195 x 150 cm
Overzet-tafelsloop	1	1301901	76 x 145 cm
Baby Handdoekje	1	1301935	80 x 90 cm
Handdoekje	2	1307245	34 x 61 cm

7 pakketten per doos

4.5 Gynaecologie-Urologie Lakens

4.5.1 Gyn-Uro laken, 345 x 75/265/180 cm met beenhoezen SMS

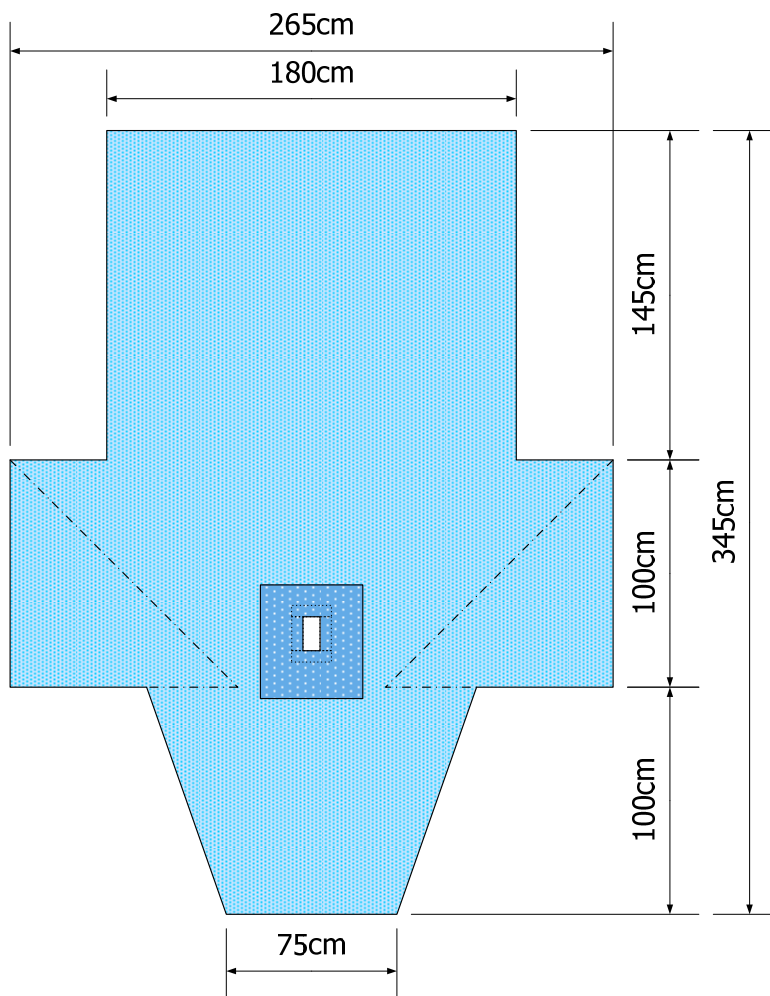



● SMS ● PSB3030

Materiaal	Afmeting	Component nummer	Bestel nummer steriel	Aantal per doos	Bestel nummer steriel	Aantal per doos
			Standaard verpakking		Eco verpakking	
SMS	345 x 75/265/180 cm	1301932	106239AA		11059EG	15
Verstreckte absorberende zone van 50 x 45 cm						
Venster van 15 x 7,5 cm. Tape rond venster						

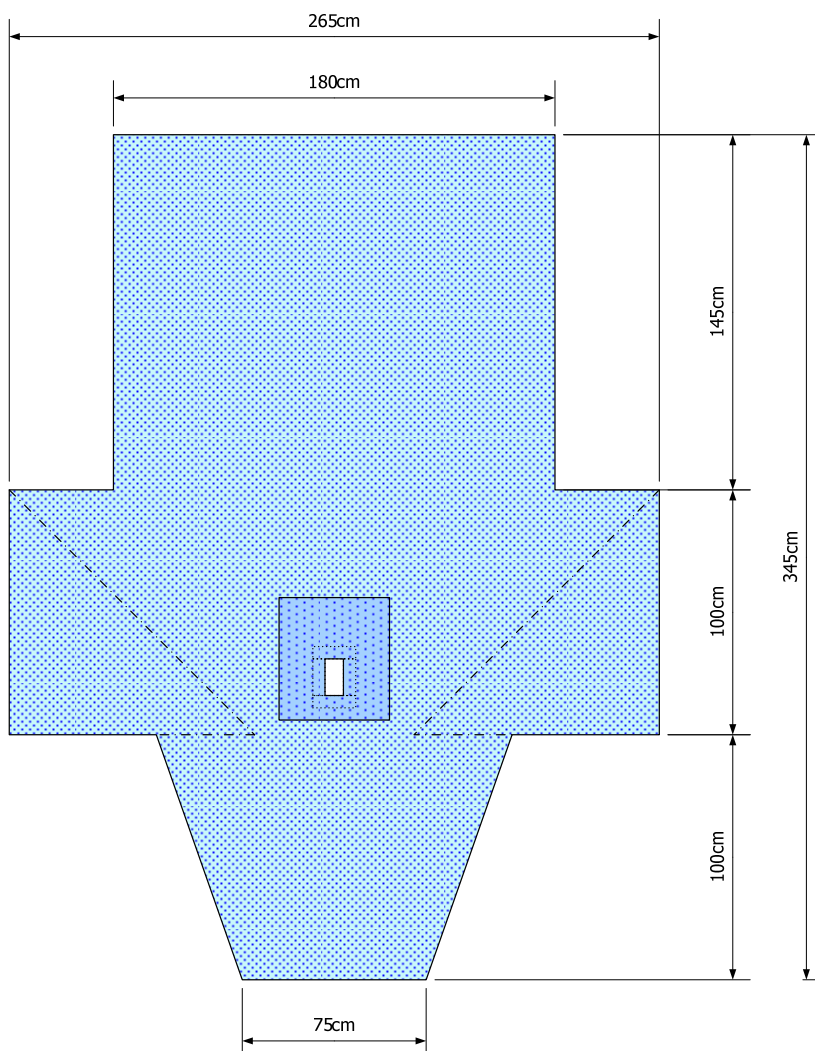
4.5.2 Gyn-Uro laken, 345 x 75/265/180 cm met beenhoezen Prestico®



 Prestico®
  SM Pad

Materiaal	Afmeting	Component nummer	Bestel nummer steriel	Aantal per doos	Bestel nummer steriel	Aantal per doos
Prestico®	345 x 75/265/180 cm	1302471	106240AA	Standaard verpakking	Eco verpakking	

Verstreckte absorberende zone van 50 x 45 cm

Venster van 15 x 7,5 cm. Tape rond venster

4.5.3 Gyn-Uro laken, 335 x 75/145/265 cm met beenhoezen 3-laags

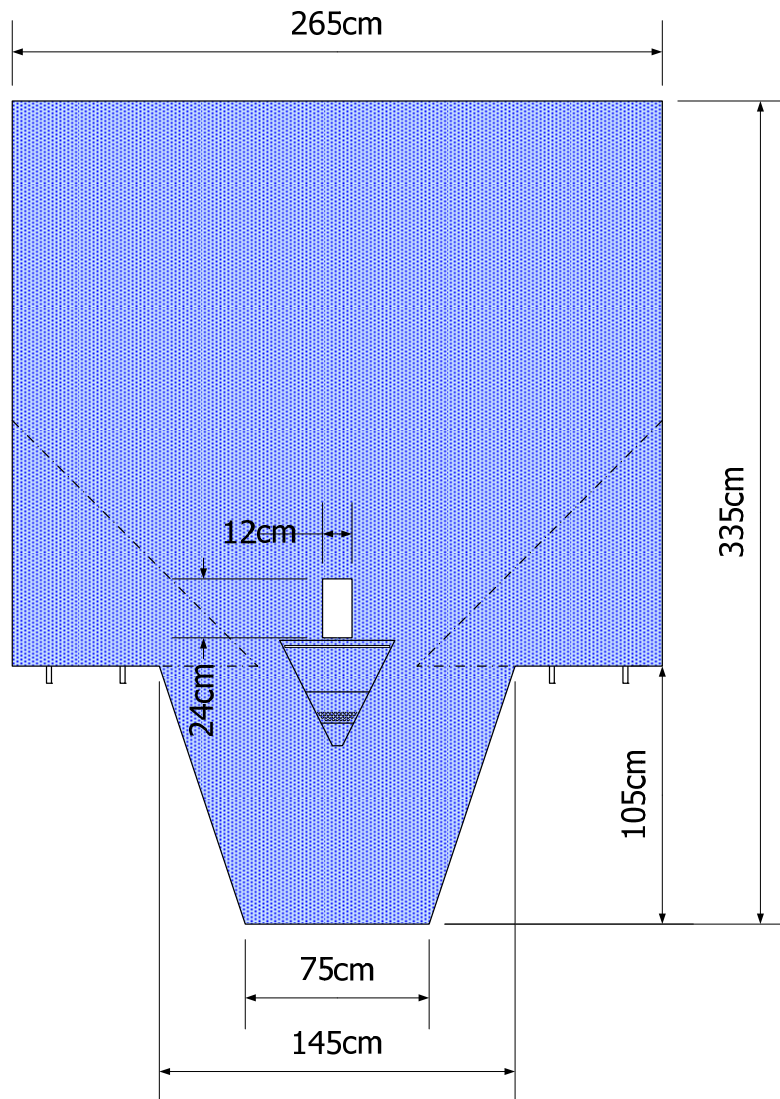



● 3-laags 60 gsm

Materiaal	Afmeting	Component nummer	Bestel nummer	Aantal per doos	Bestel nummer	Aantal per doos
			steriel		steriel	
			Standaard verpakking		Eco verpakking	
3-laags 60 gsm	335 x 75/145/265 cm	1307378				

Beenhoezen met 4 stukken bevestigingstape
Vloeistofopvangzak met filter

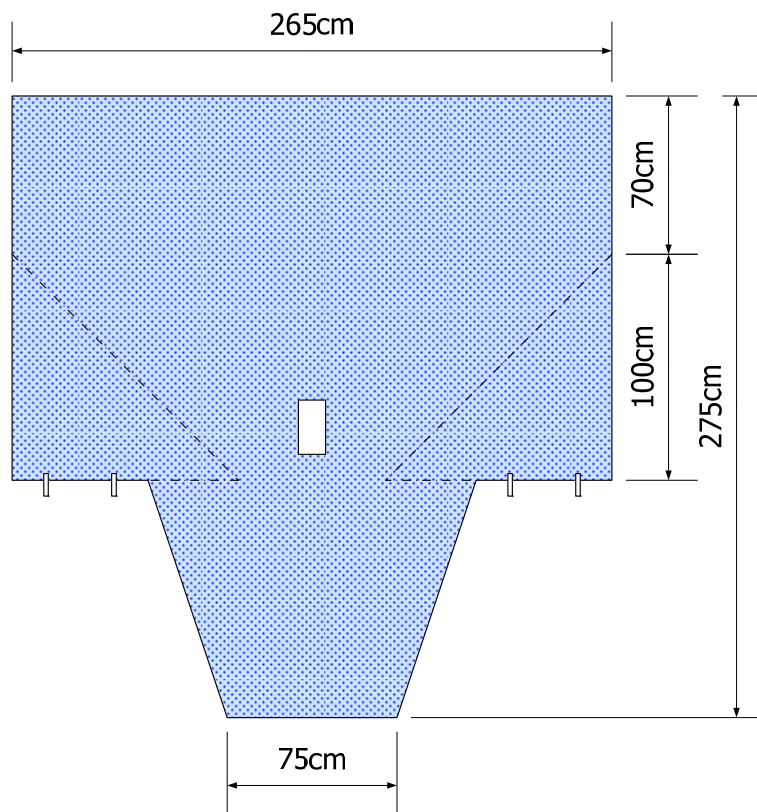
4.5.4 Gyn-Uro laken, 275 x 75/265 cm met beenhoezen



 2-laags

Materiaal	Afmeting	Component nummer	Bestel nummer steriel	Aantal per doos	Bestel nummer steriel	Aantal per doos
			Standaard verpakking		Eco verpakking	
2-laags	275 x 75/265cm	1302127	104537AA	5		
Venster 24 x 12cm						

4.5.5 Gyn-Uro laken, 115 x 60 cm

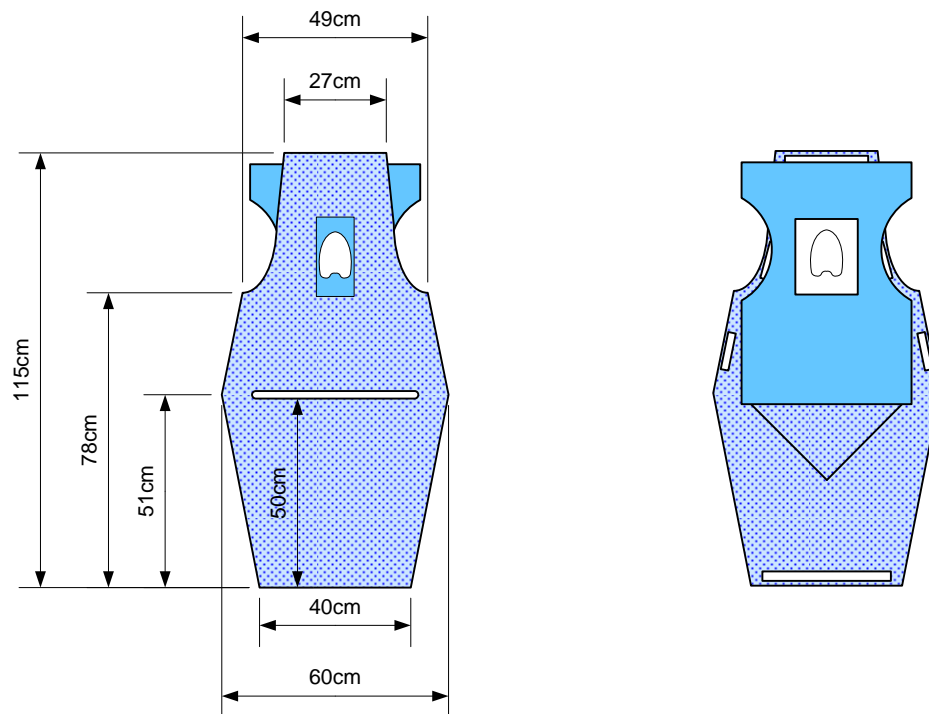

 2-laags
  PE Film

Materiaal	Afmeting	Component nummer	Bestel nummer steriel	Aantal per doos	Bestel nummer steriel	Aantal per doos
			Standaard verpakking		Eco verpakking	
2-laags	115 x 60 cm	1302128	104538AA	60		

Hartvormig venster

Vloeistofopvangzak

4 x Tape 2 x 10cm

4.6 Laparotomie-Gynaecologie lakens

4.6.1 Lap-Gyn laken, 225 x 255/180/225 cm met arm board covers en beenhoezen

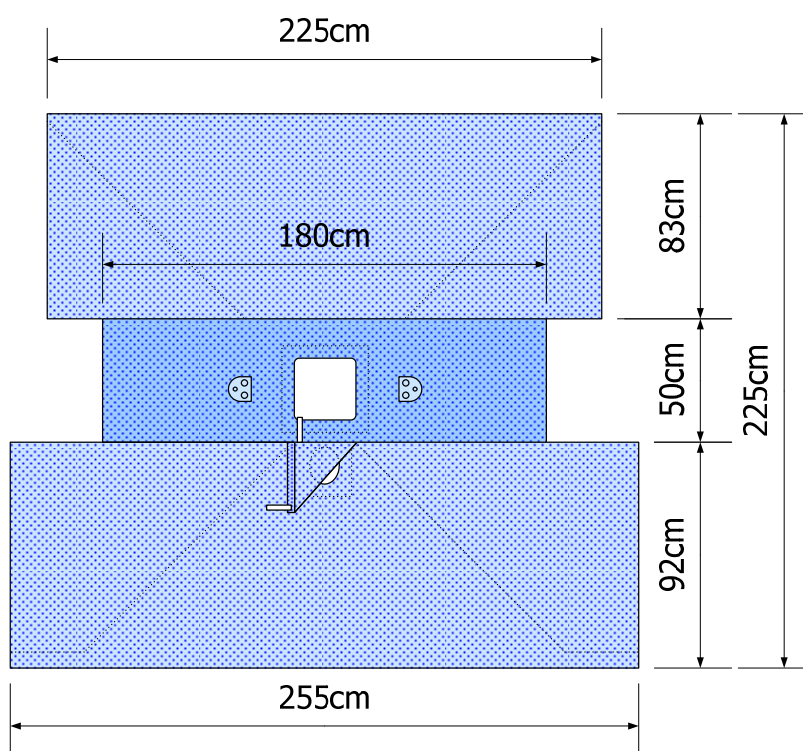

● 3-laags ○ 2-laags

Materiaal	Afmeting	Component nummer	Bestel nummer steriel	Aantal per doos	Bestel nummer steriel	Aantal per doos
			Standaard verpakking		Eco verpakking	
2/3-laags	225x255/180/225cm	1307383				
Laparotomie Venster 23 x 19 cm met tape						
Gynaecologie Venster ovaal 12 x 15 cm met tape						

4.6.2 Lap-Gyn-HIPEC laken, 291 x 275/210/260 cm met armsteunbedekking an beenhoezen

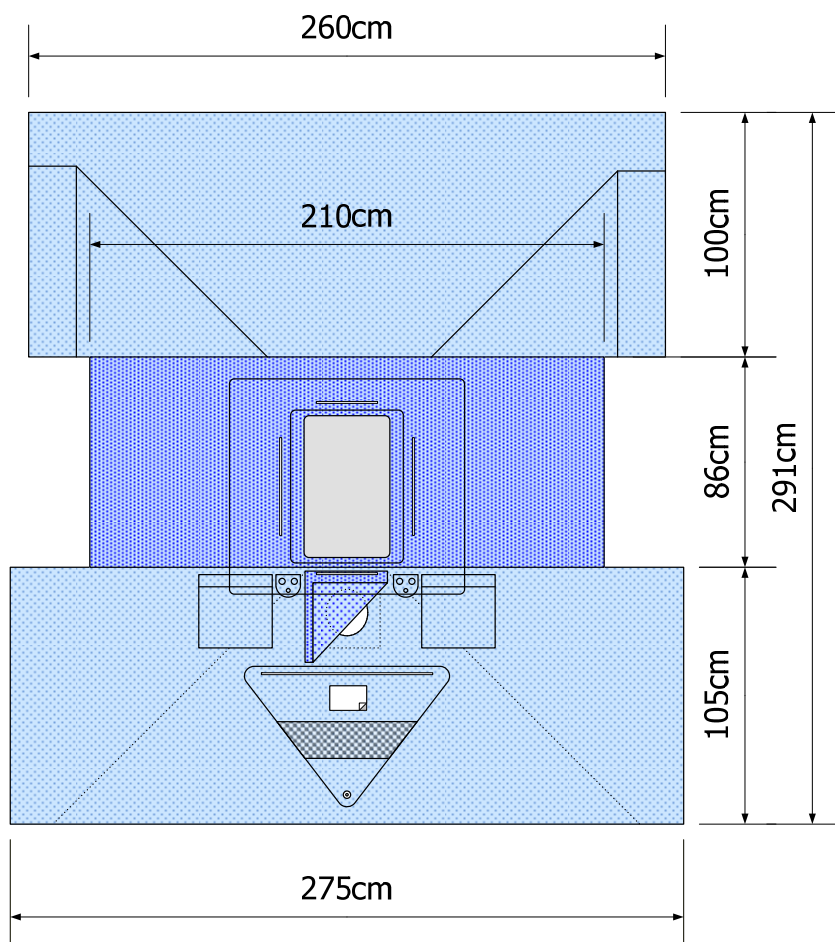

3-laags
 2-laags
 Incisie tape

Materiaal	Afmeting	Component nummer	Bestel nummer steriel	Aantal per doos	Bestel nummer steriel	Aantal per doos
				Standaard verpakking	Eco verpakking	
2/3-laags	291x275/210/260 cm	1302182	102892AA			

Laparotomie Venster 58 x 36 cm met volledig Incisie tape

Gynaecologie Venster Ovaal 19x17 cm

Vloeistofopvangzak

2 diathermie zakken 30x30cm

4.7 C-Sectio lakens

4.7.1 C-Sectio laken met vloeistofopvangzak, volledig Incisie film SMS

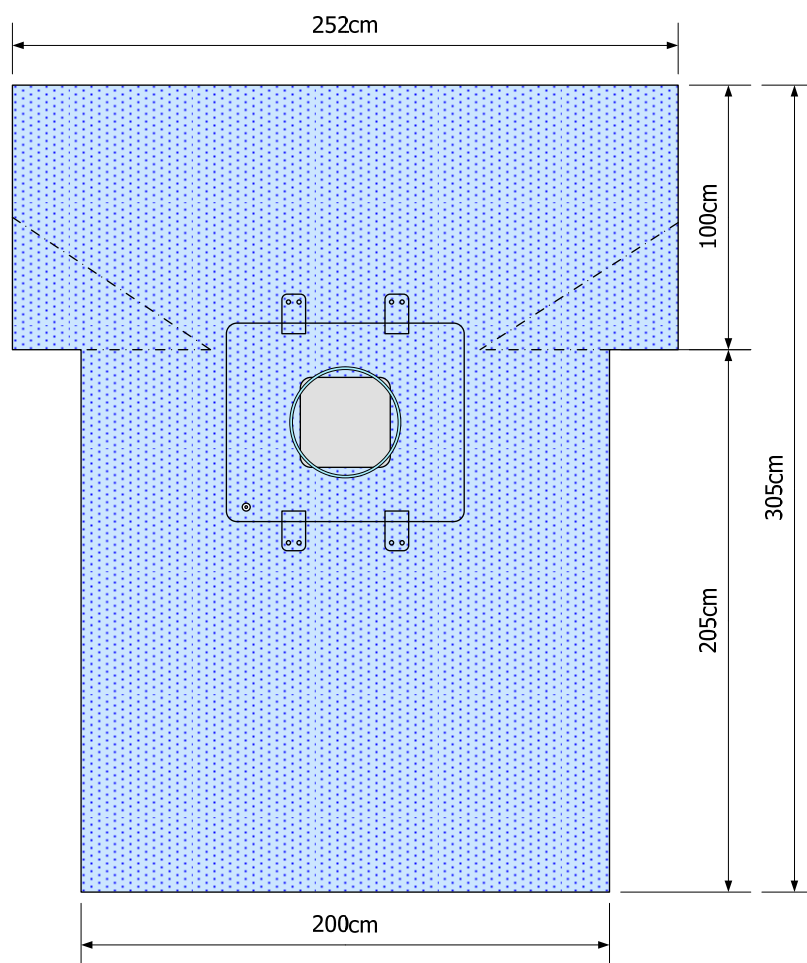

● SMS
 ● Incisie film

Materiaal	Afmeting	Component nummer	Bestel nummer steriel	Aantal per doos	Bestel nummer steriel	Aantal per doos
			Standaard verpakking		Eco verpakking	
SMS	305 x 200/252 cm	1307266				
Vloeistofopvangzak met ventiel port 75 x 90 cm en foam plastic band						
Volledig Incisie film						
4 Slangenhouders						

4.7.2 C-Section laken met vloeistofopvangzak, Gat Incisie film en beenhoezen SMS

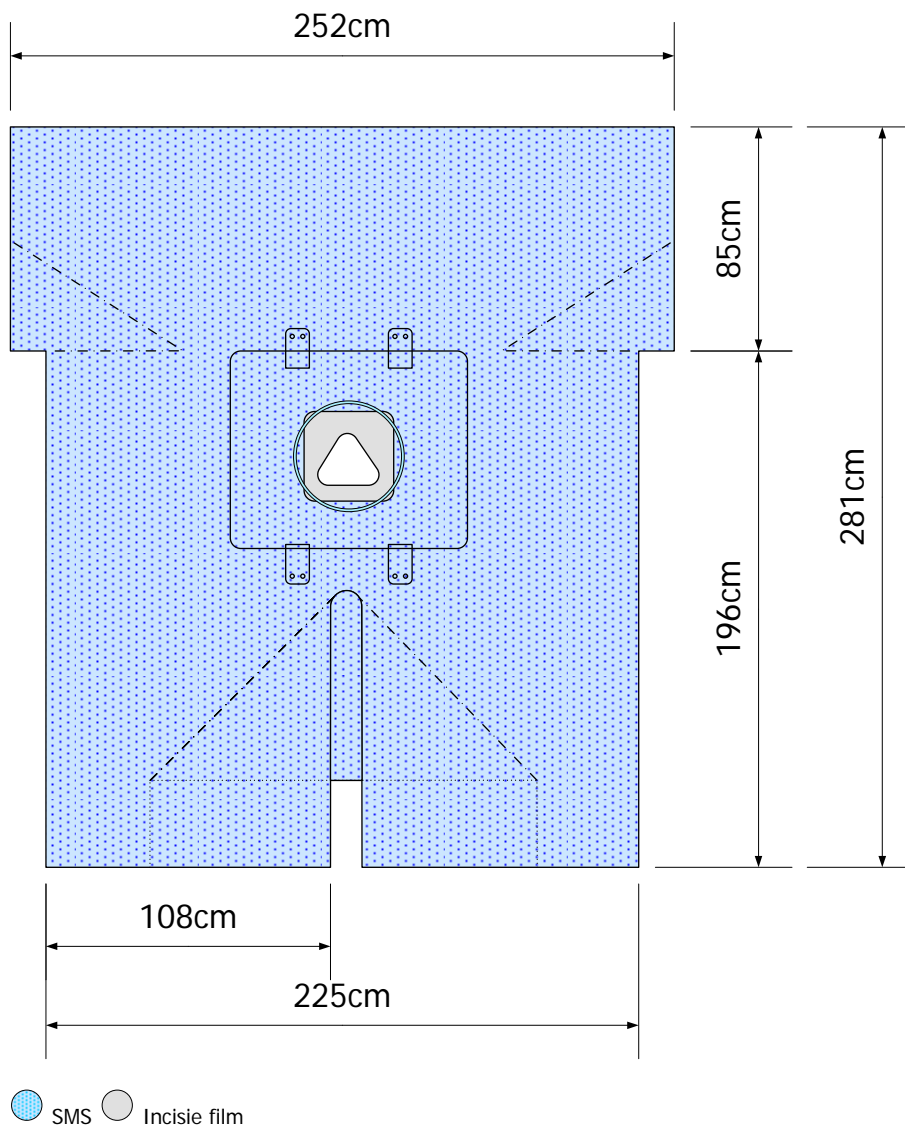

Materiaal	Afmeting	Component nummer	Bestel nummer steriel	Aantal per doos	Bestel nummer steriel	Aantal per doos
SMS	281 x 225/252 cm	1301934	106241AA	Standaard verpakking	Eco verpakking	11060EG 16

Vloeistofopvangzak met venietel 75 x 90 cm en foam plastic band
 Venster met Incisie film en driehoekig uitsparing van 25 x 20 cm
 4 Slangenhouders

4.7.3 C-Section laken met vloeistofopvangzak, volledig Incisie film Prestico®

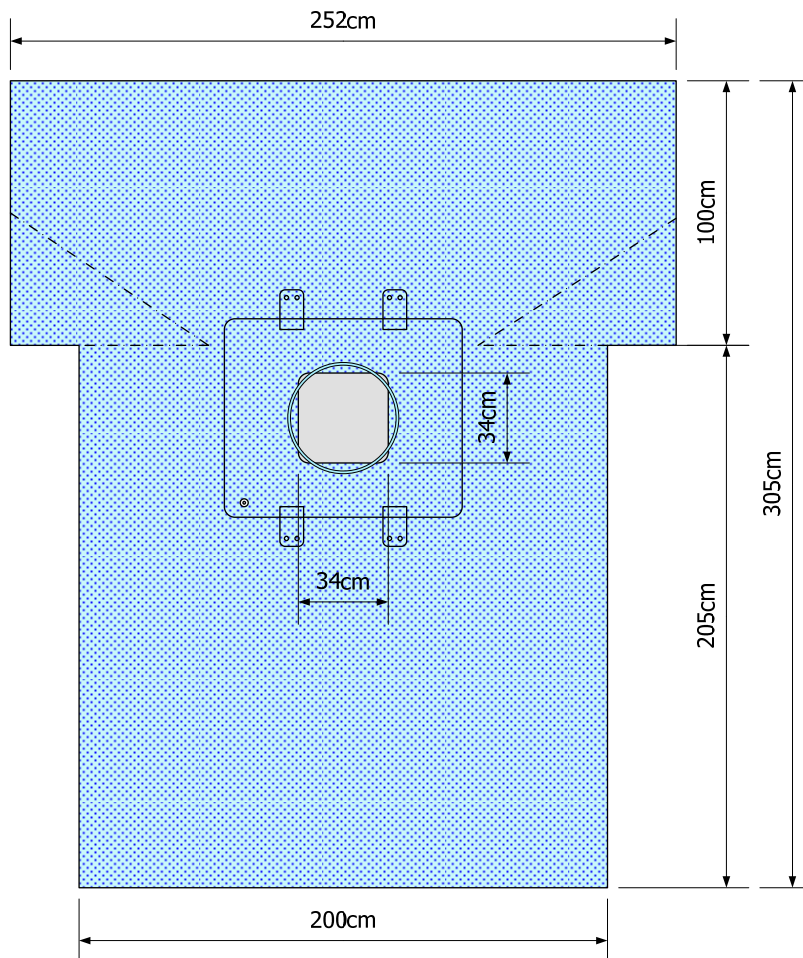

 Prestico®
  Incisie film

Materiaal	Afmeting	Component nummer	Bestel nummer steriel	Aantal per doos	Bestel nummer steriel	Aantal per doos
Prestico®	305 x 200/252 cm	1302473	106242AA	Standaard verpakking	Eco verpakking	
Vloeistofopvangzak met ventiel port 75 x 90 cm en foam plastic band						
Venster met volledig Incisie film 34 x 34 cm						
4 Slangenhouders						
Armsteun bedekkingen						

4.7.4 C-Section laken met vloeistofopvangzak, Gat Incisie film Prestico®

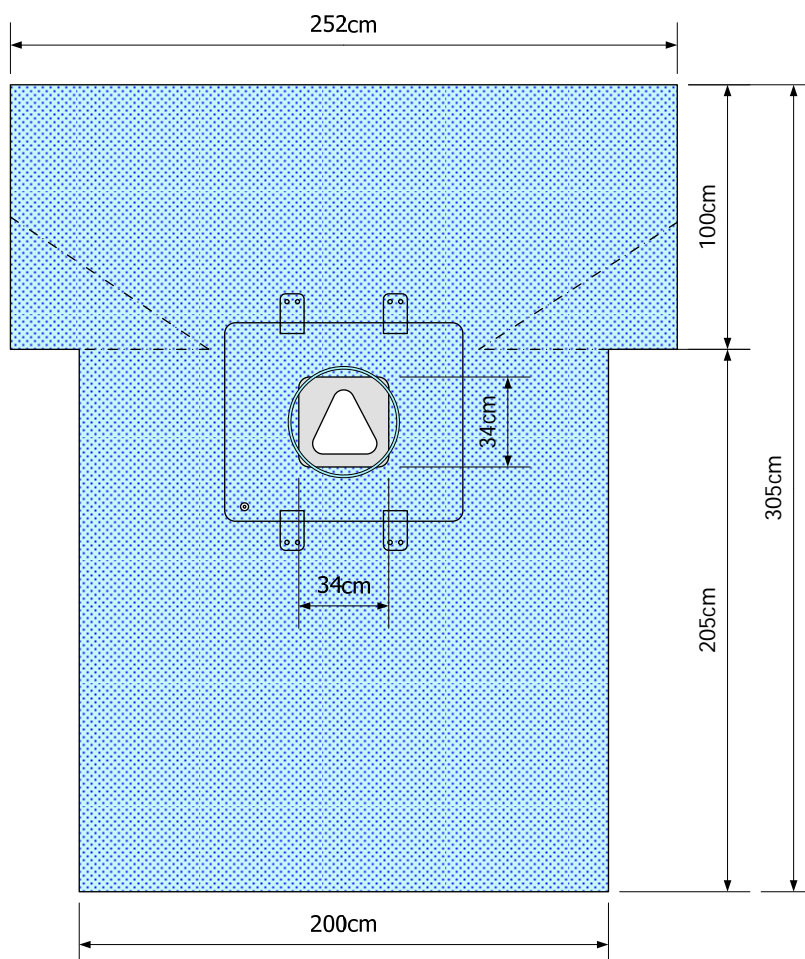

 Prestico®
  Incisie film

Materiaal	Afmeting	Component nummer	Bestel nummer steriel	Aantal per doos	Bestel nummer steriel	Aantal per doos
Prestico®	305 x 200/252 cm	1302476	106243AA			
			Standaard verpakking		Eco verpakking	

Vloeistofopvangzak met ventiel 75 x 90 cm en foam plastic band

Venster van 34 x 34 cm met Incisie film en driehoekig uitsparing van 25 x 20 cm

4 Slanghouders

Armsteun bedekkingen

4.7.5 C-Section laken met vloeistofopvangzak, volledig Incisie film 3-laags

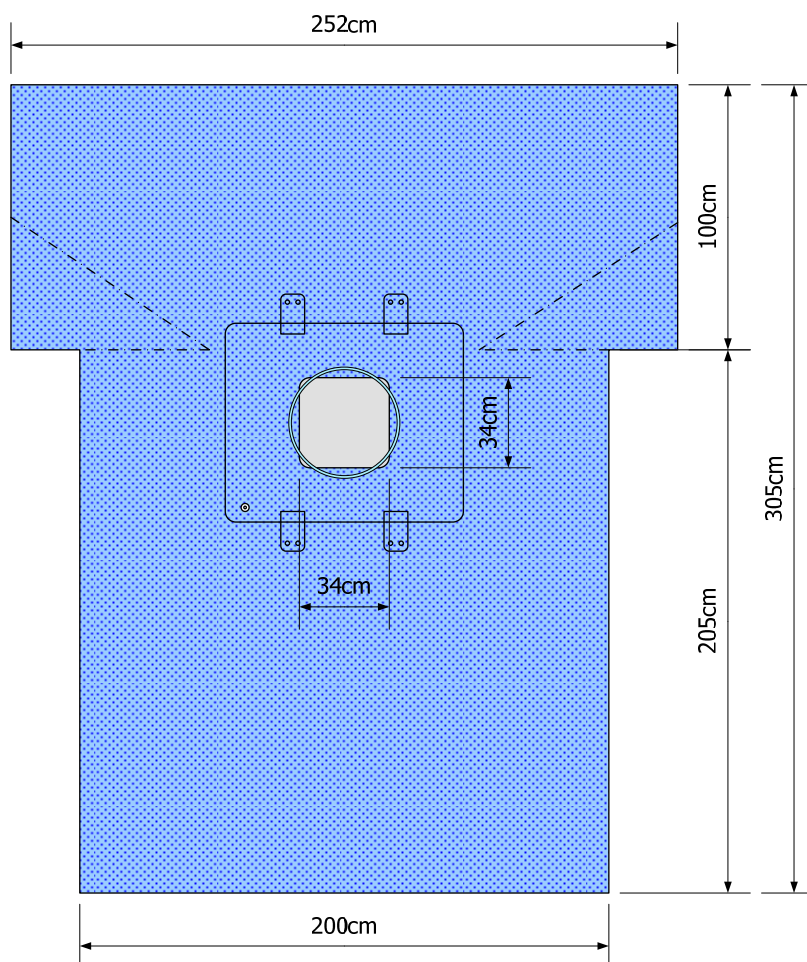

3-laags 60 gsm
 Incisie tape

Materiaal	Afmeting	Component nummer	Bestel nummer steriel	Aantal per doos	Bestel nummer steriel	Aantal per doos
3-laags	305 x 200/252 cm	1302563	Standaard verpakking		Eco verpakking	
Vloeistofopvangzak met ventiel 75 x 90 cm en foam plastic band						
Volledige Incisie tape						
4 Slangenhouders						
Armsteun bedekkingen						

4.7.6 C-Section laken met vloeistofopvangzak, Gat Incisie film 3-laags

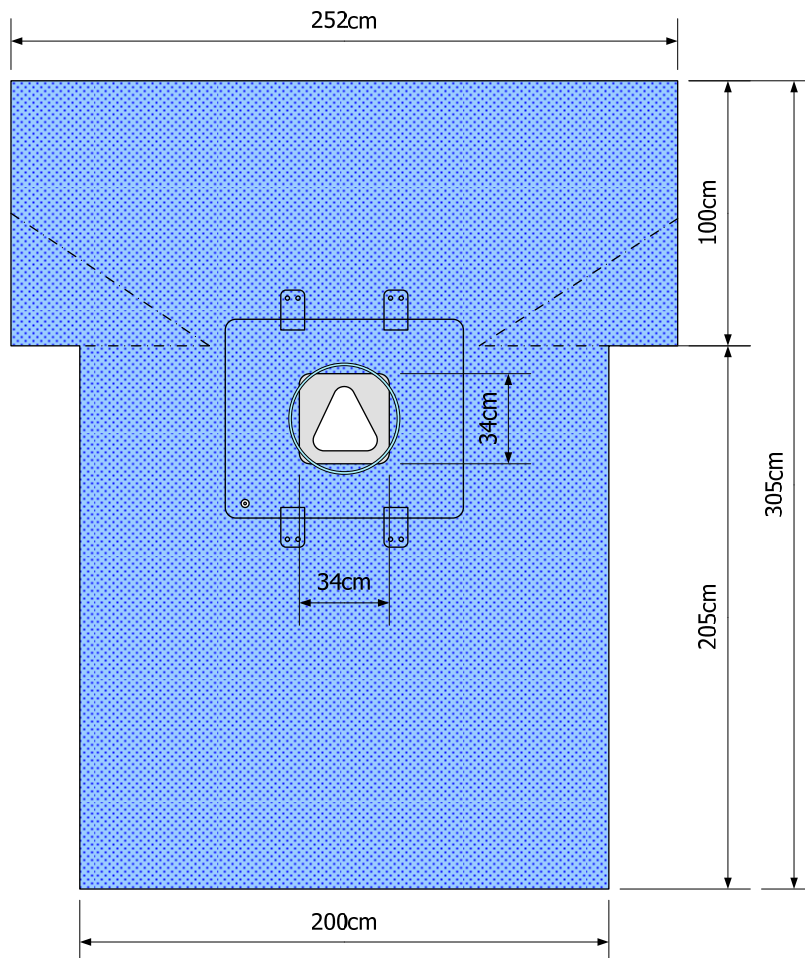

3-laags 60 gsm
 Incisie tape

Materiaal	Afmeting	Component nummer	Bestel nummer steriel	Aantal per doos	Bestel nummer steriel	Aantal per doos
3-laags	305 x 200/252 cm	1302639	Standaard verpakking		Eco verpakking	

Vloeistofopvangzak met ventiel 75 x 90 cm en foam plastic band

Venster van 34 x 34 cm met Incisie film en driehoekige uitsparing van 25 x 20 cm

4 Slangenhouders

Armsteun bedekkingen

4.8 T.U.R. Lakens

4.8.1 T.U.R. laken

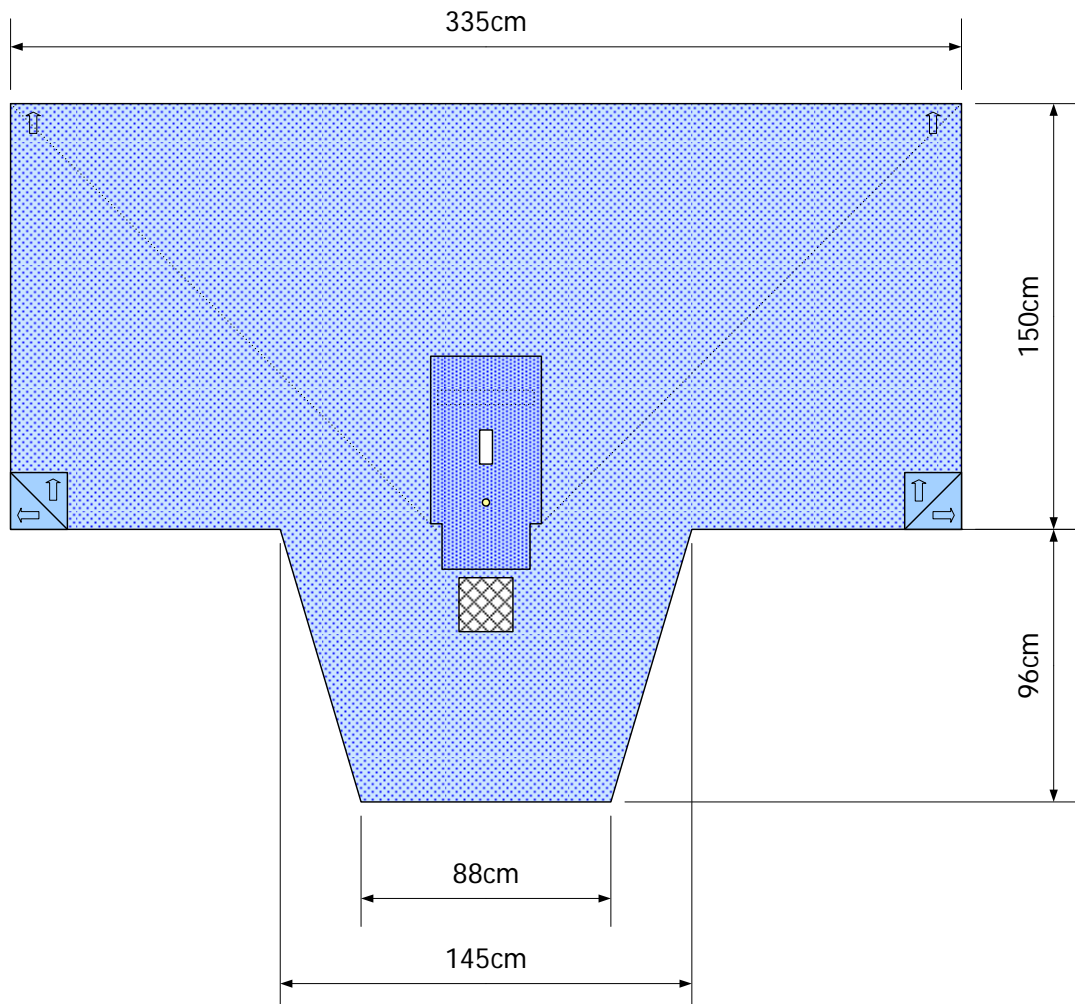

● 2-laags ● absorberend materiaal

Materiaal	Afmeting	Component nummer	Bestel nummer steriel	Aantal per doos	Bestel nummer steriel	Aantal per doos
2-laags	226 x 88/295 cm	1302566	106244AA			

Versterking zone	65 x 39 cm
Venster van	12 x 5 cm en latex vrij vinger condoom
Beenhoezen	
Venster met filter van	19 x 19 cm

4.8.2 T.U.R. laken met Vloeistofopvangzak

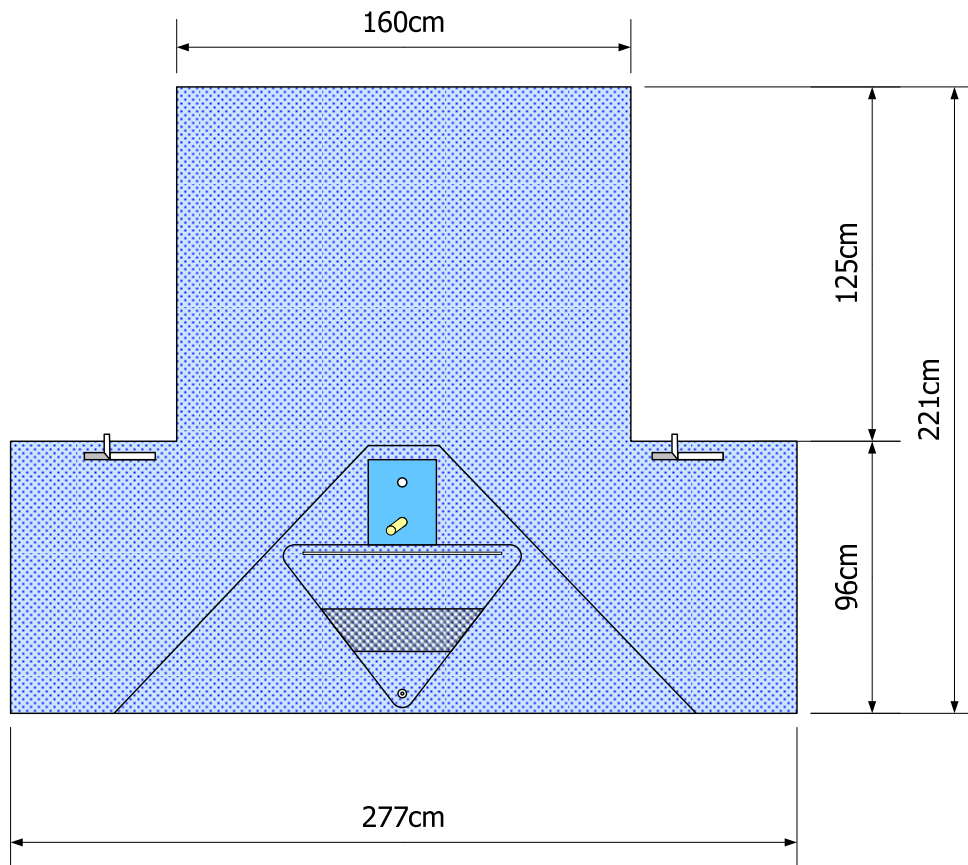

● 2-laags ● Polyethyleen film

Materiaal	Afmeting	Component nummer	Bestel nummer steriel	Aantal per doos	Bestel nummer steriel	Aantal per doos
			Standaard verpakking		Eco verpakking	
2-laags	221 x 277/160 cm	1302399	106246AA			

Driehoekige vloeistofopvangzak

Venster Ø 7 cm met tape zone van 12 x 18 cm

Venster in Polyethyleen en latex free finger condoom

Beenhoezen

Tape strips 2,5 cm breed

4.9 Nephroscopie laken

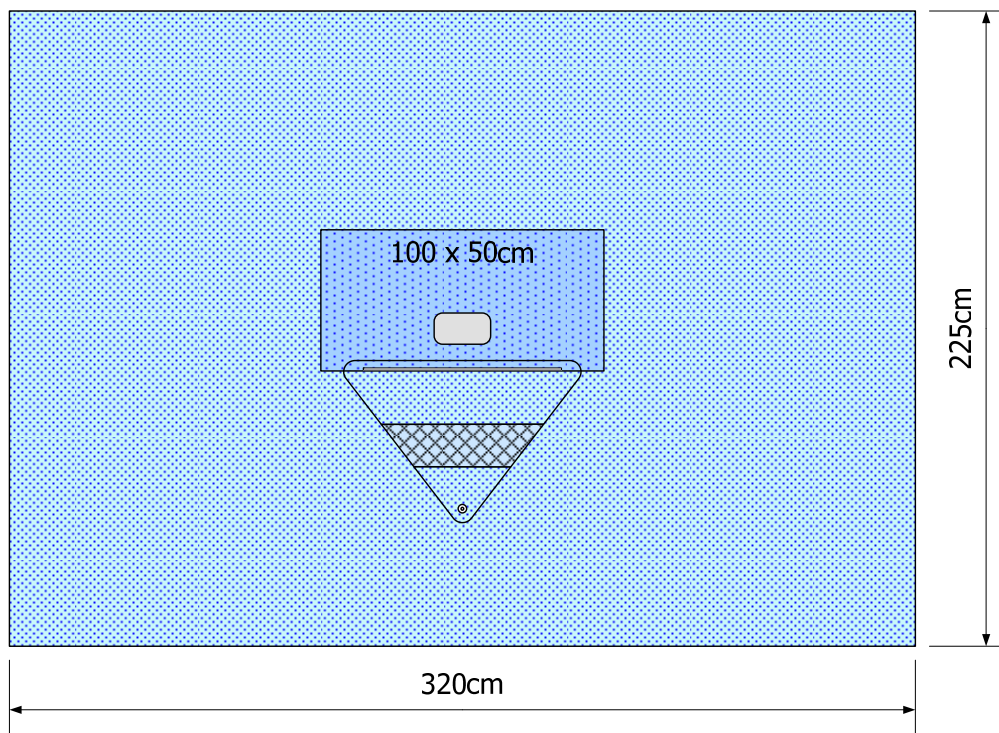

Materiaal	Afmeting	Component nummer	Bestel nummer	Aantal	Bestel nummer	Aantal
			steriel	per doos	steriel	per doos
Prestico®	255 x 320cm	1302484	Standaard verpakking		Eco verpakking	
			106247AA			

Venster 11 x 20cm met volledige Incisie film
 Driehoekige vloeistofopvangzak, 92 cm breed en 60 cm hoog, met filter en ventiel

5 Oogheelkunde

5.1 Ooglaken, ovaal Venster, vloeistofopvangzaken

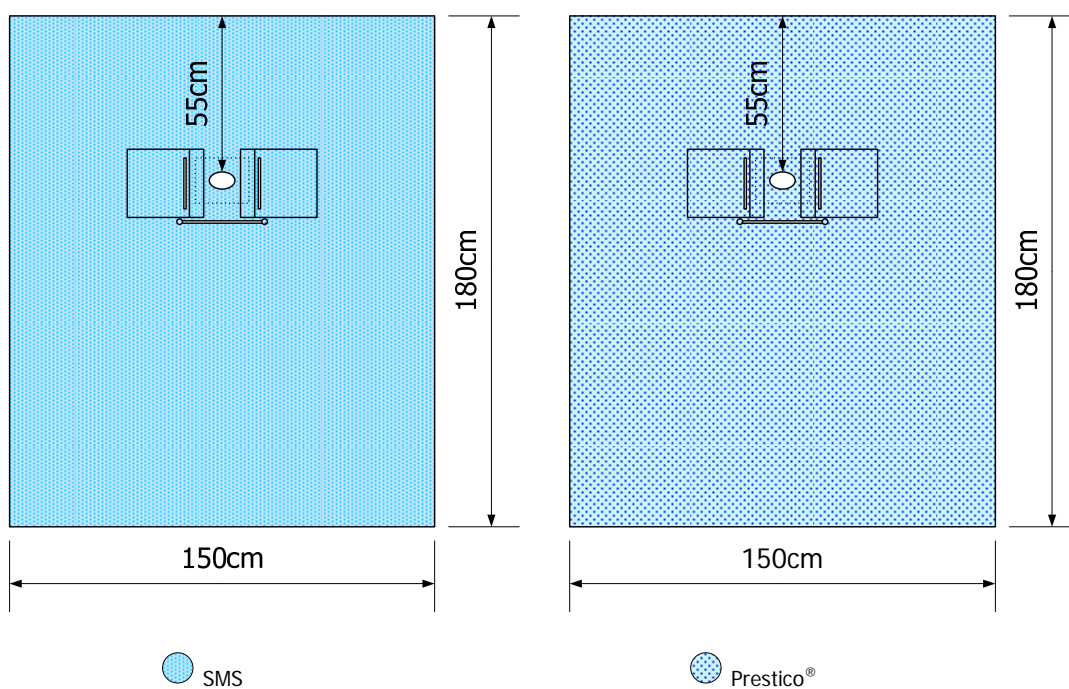

Materiaal	Afmeting	Component nummer	Bestel nummer	Aantal	Bestel nummer	Aantal
			steriel	per doos	steriel	per doos
			Standaard verpakking		Eco verpakking	
SMS	180 x 150cm	1302235	106248AA		11061EG	2x18
Prestico®	180 x 150cm	1302541	106274AA			

Ovaal venster 6 x 9 cm
 2 Vloeistofopvangzaken
 Flexwire
 Tape 16 x 19cm

5.2 Ooglakken, ovaal Venster, vloeistofopvangzaken, Incisie tape

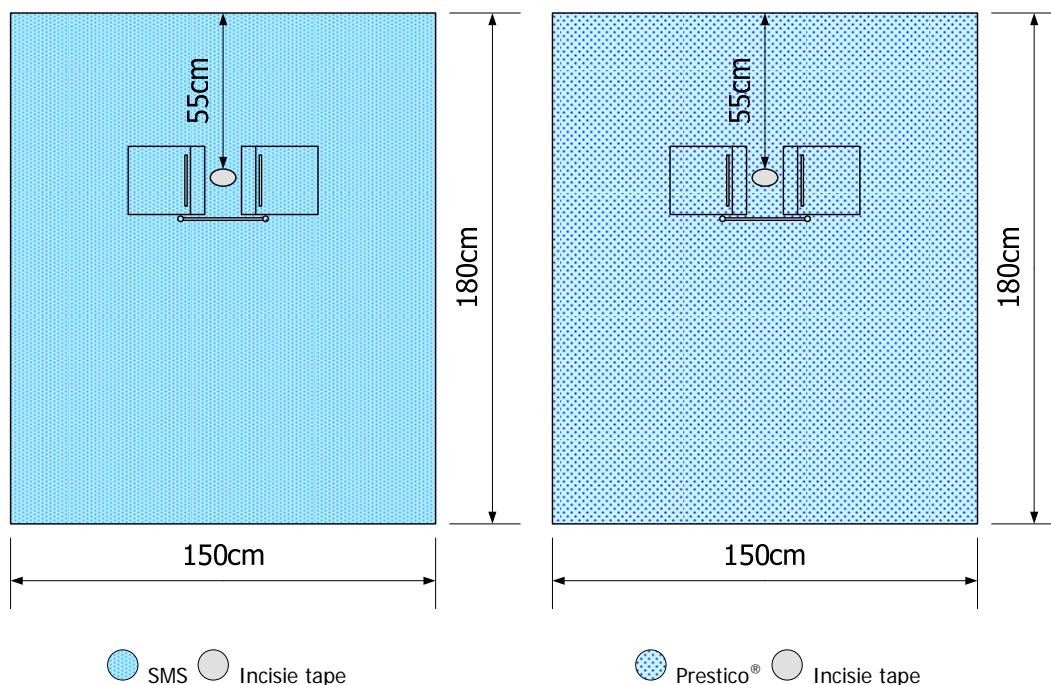

Materiaal	Afmeting	Component nummer	Bestel nummer steriel	Aantal per doos	Bestel nummer steriel	Aantal per doos
				Standaard verpakking		
SMS	180 x 150cm	1302236	103853AA		11062EG	2x18
Prestico®	180 x 150cm	1302567	106250AA			

Ovaal Venster 6 x 9 cm

2 Vloeistofopvangzaken

Flexwire

Incisie tape

5.3 Ooglakken, vierkant venster en vloeistofopvangzaken

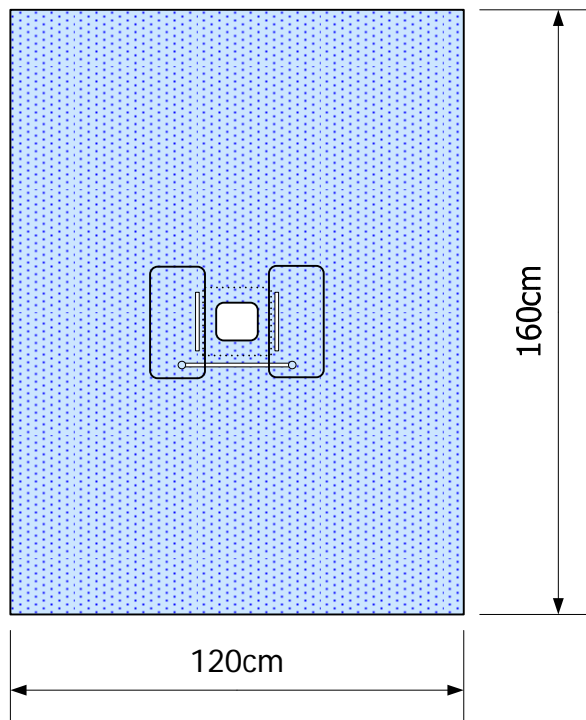

 SMS

Materiaal	Afmeting	Component nummer	Bestel nummer steriel	Aantal per doos	Bestel nummer steriel	Aantal per doos
SMS	160 x 120cm	1301904	104539AA	Standaard verpakking	Eco verpakking	

Vierkant Venster 10 x 11cm

2 vloeistofopvangzaken 29 x 15cm

Neusbrug (flexwire)

5.4 Oog laken, vierkant Venster, vloeistofopvangzakes en Incisie film

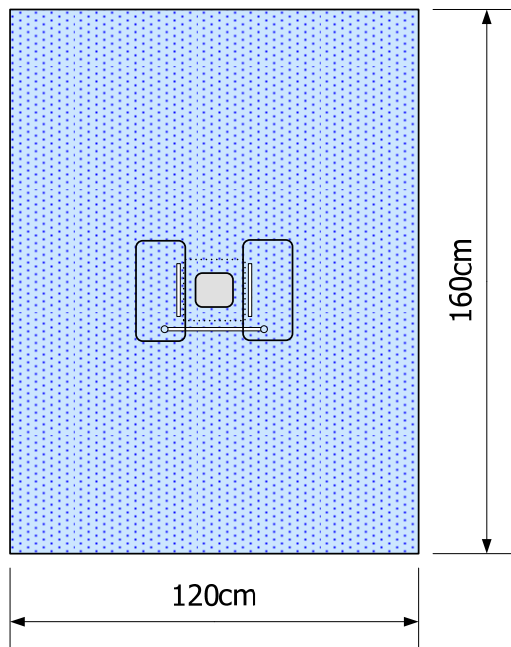

 SMS
  Incisie film

Materiaal	Afmeting	Component nummer	Bestel nummer steriel	Aantal per doos	Bestel nummer steriel	Aantal per doos
SMS	160 x 120cm	1301725	104540AA	15		
Vierkant Venster 10 x 11cm			Standaard verpakking		Eco verpakking	
Volledig Incisie film						
2 vloeistofopvangzaken 29 x 15cm						
Neusbrug (flexwire)						

5.5 Ooglaken, vierkant Venster en vloeistofopvangzak

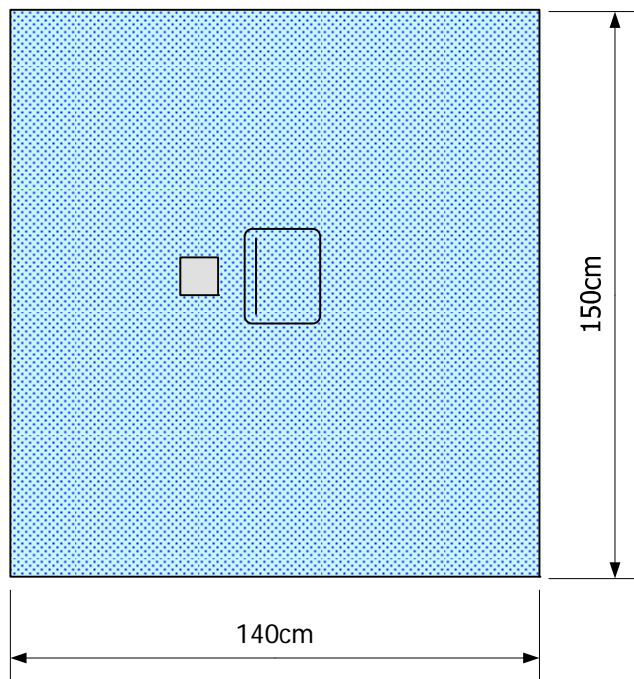

 Prestico®
  Incisie film

Materiaal	Afmeting	Component nummer	Bestel nummer steriel	Aantal per doos	Bestel nummer steriel	Aantal per doos
Prestico®	150 x 140cm	1302477	106251AA	Standaard verpakking	Eco verpakking	
Vierkant Venster 10 x 10cm						
Volledig Incisie film						
Vloeistofopvangzak						

6 KNO (Keel-Neus-Oor) en Neurologie

6.1 Thyroid pack SMS

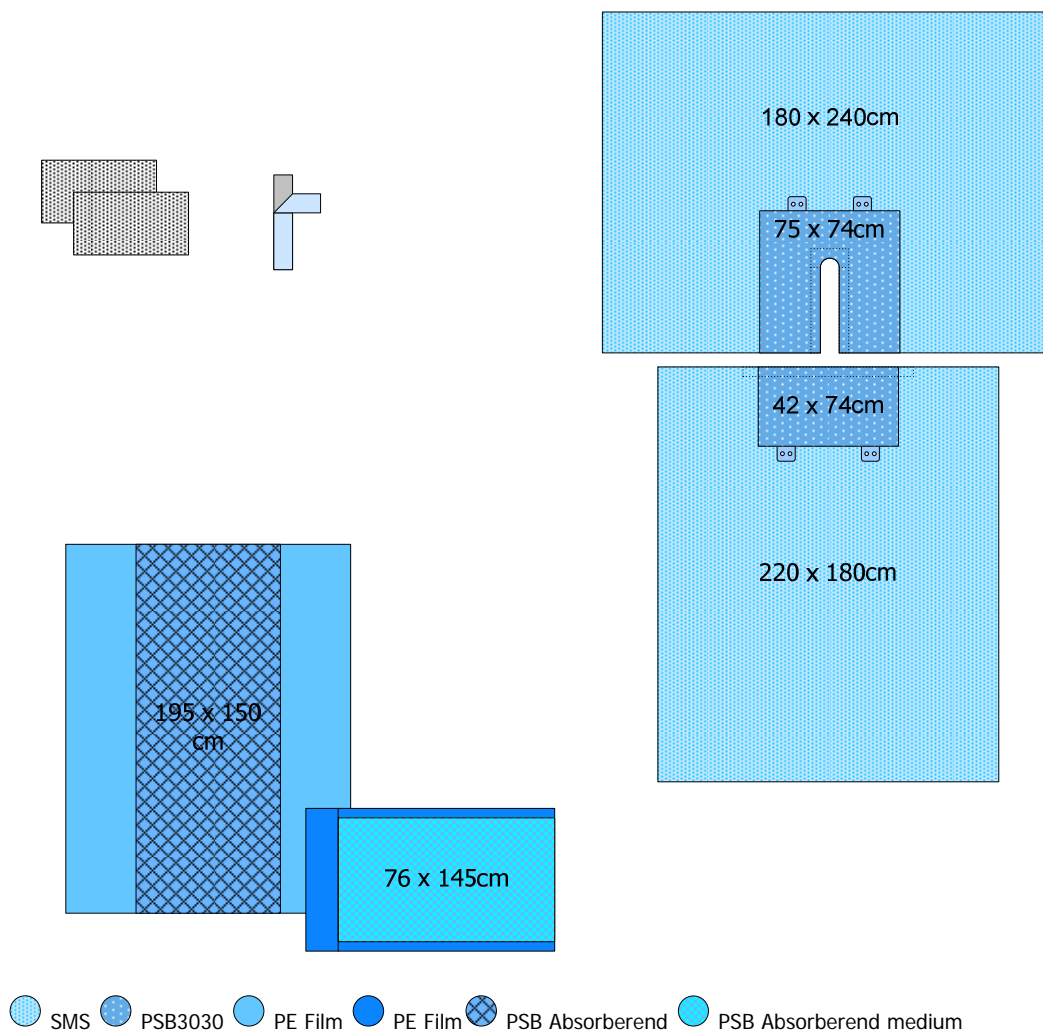

11010EG Thyroid Pakket SMS

Omschrijving	aantal	Component nummer	afmetingen
Splitlaken, 50x10cm, met tape	1	1301982	180 x 240 cm
Onderlaken, extra long met tape	1	1301980	180 x 180 cm
Instrumentenveld	1	1306755	195 x 150 cm
Overzet-tafelsloop medium duty	1	1301901	76 x 145 cm
Tapestrip	1	1301916	10 x 50 cm
Handdoekje	2	1307245	34 x 61 cm

14 per doos

6.2 Hoofdlaken

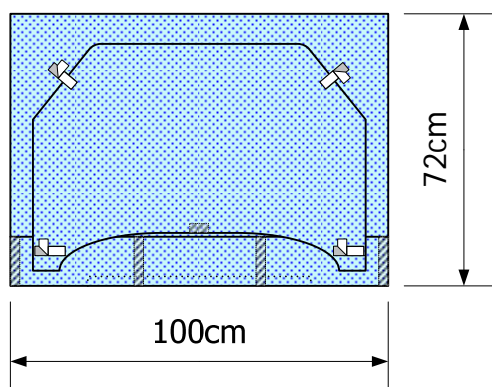

 Prestico®

Materiaal	Afmeting	Component nummer	Bestel nummer	Aantal per doos	Bestel nummer	Aantal per doos
			steriel		steriel	
			Standaard verpakking		Eco verpakking	
Prestico®	72 x 100 cm	1302480	106252AA			
Tape 2,5 cm breed						

6.3 Hoofdlaken 2-delen

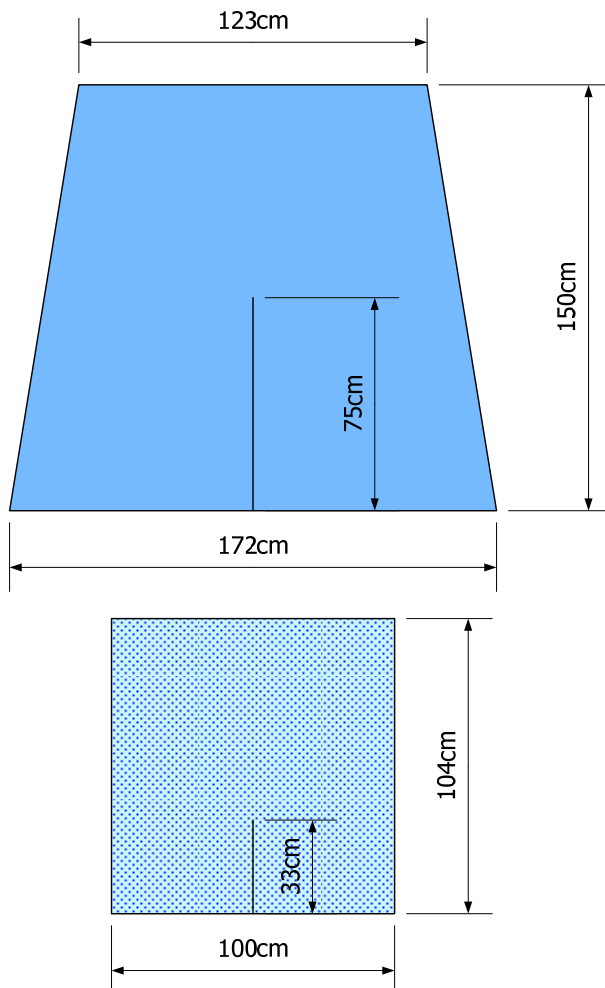

Materiaal	Afmeting	Component nummer	Bestel nummer steriel	Aantal per doos	Bestel nummer steriel	Aantal per doos
2-laags/ Prestico®	150 x 172 cm 104 x 100 cm	1302482	Standaard verpakking 106253AA		Eco verpakking	

6.4 Gezichtsblaken

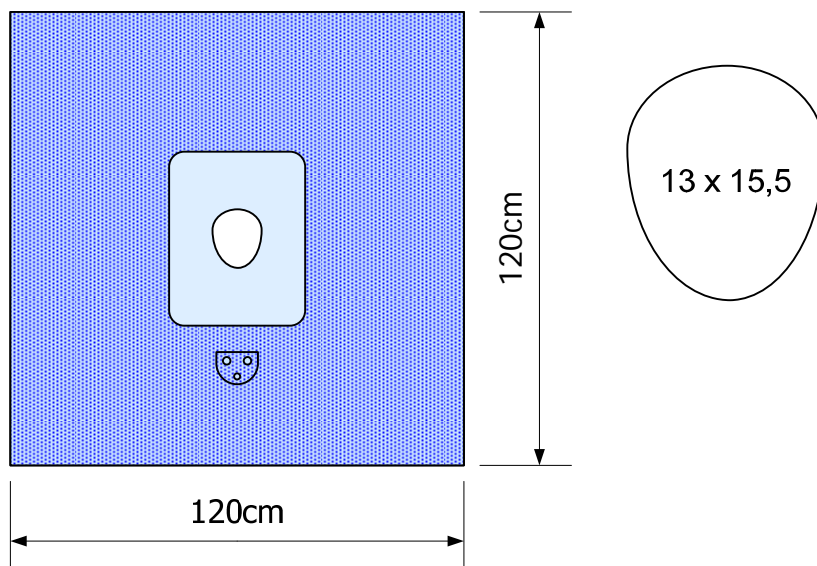

● 3-laags ○ Elastisch materiaal

Materiaal	Afmeting	Component nummer	Bestel nummer	Aantal per doos	Bestel nummer	Aantal per doos
			steriel	Standaard verpakking	steriel	Eco verpakking
3-laags	120 x 120 cm	1301961	103847AA	50		

6.5 Mondheelkunde lakens

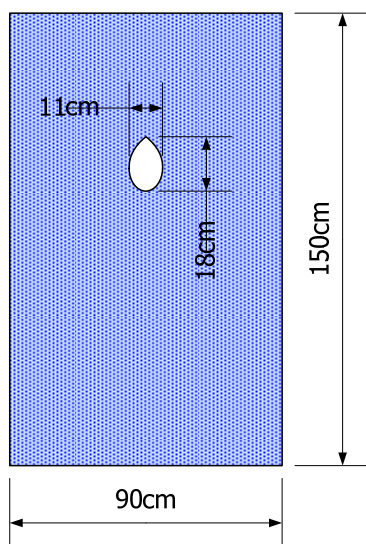

 3-laags

Materiaal	Afmeting	Component nummer	Bestel nummer steriel	Aantal per doos	Bestel nummer steriel	Aantal per doos
			Standaard verpakking		Eco verpakking	
3-laags	150 x 90 cm	1302425	103647AA	20		

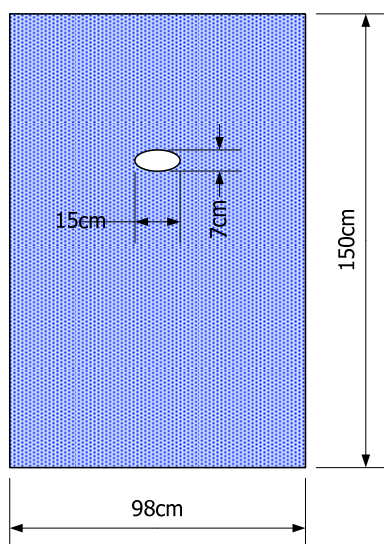



 3-laags

Materiaal	Afmeting	Component nummer	Bestel nummer steriel	Aantal per doos	Bestel nummer steriel	Aantal per doos
			Standaard verpakking		Eco verpakking	
3-laags	150 x 98 cm	1301342	103495AA	15		

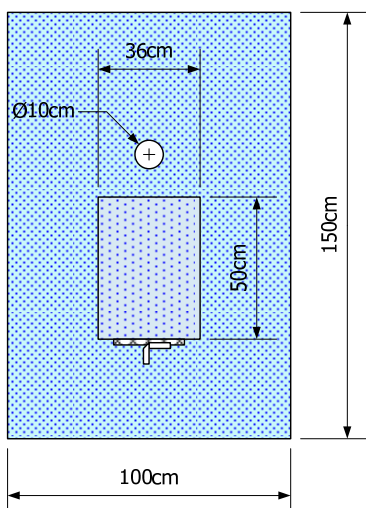
6.5 Mondheelkunde lakens (vervolg)





 Prestico®  SM Pad

Materiaal	Afmeting	Component nummer	Bestel nummer steriel	Aantal per doos	Bestel nummer steriel	Aantal per doos
Prestico®	150 x 100 cm	1302483	106194AA	Standaard verpakking	Eco verpakking	

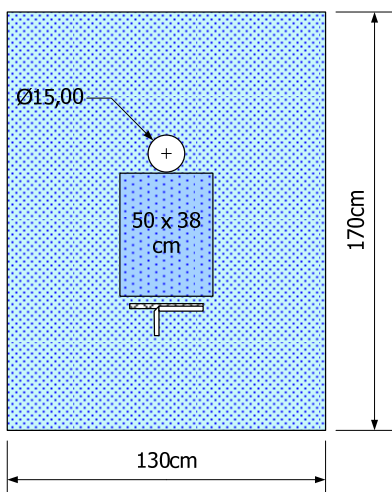
Velcro tape 25 x 2 cm met 15 x 2 cm



 Prestico®  SM Pad

Materiaal	Afmeting	Component nummer	Bestel nummer steriel	Aantal per doos	Bestel nummer steriel	Aantal per doos
Prestico®	170 x 130 cm	1302486	106195AA	Standaard verpakking	Eco verpakking	

Velcro tape 23 x 2 cm met 30 x 2 cm

6.6 Craniotomie laken

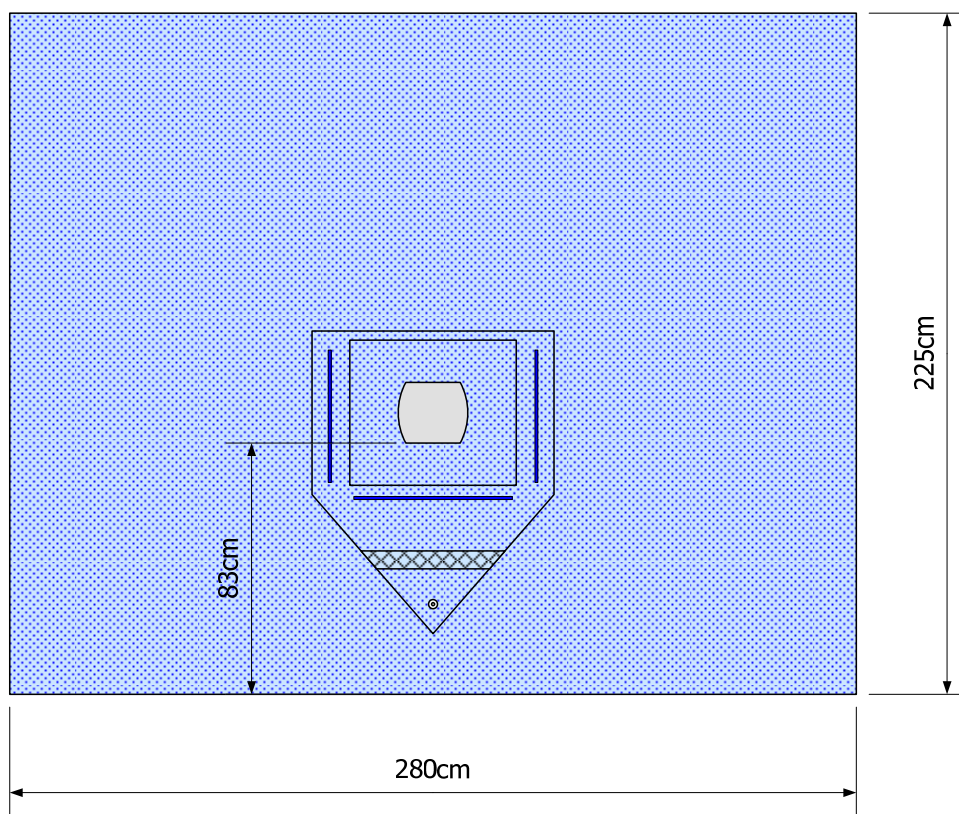

● 2-laags ○ Incisie film

Materiaal	Afmeting	Component nummer	Bestel nummer steriel	Aantal per doos	Bestel nummer steriel	Aantal per doos
2-laags	225 x 280 cm	1301963	103698AA	10	Standaard verpakking	Eco verpakking
Vloeistofopvangzak met filter						
Venster 20 x 23cm met volledige incisie tape						

7 Cardiovasculair

7.1 Cardiovasculair laken

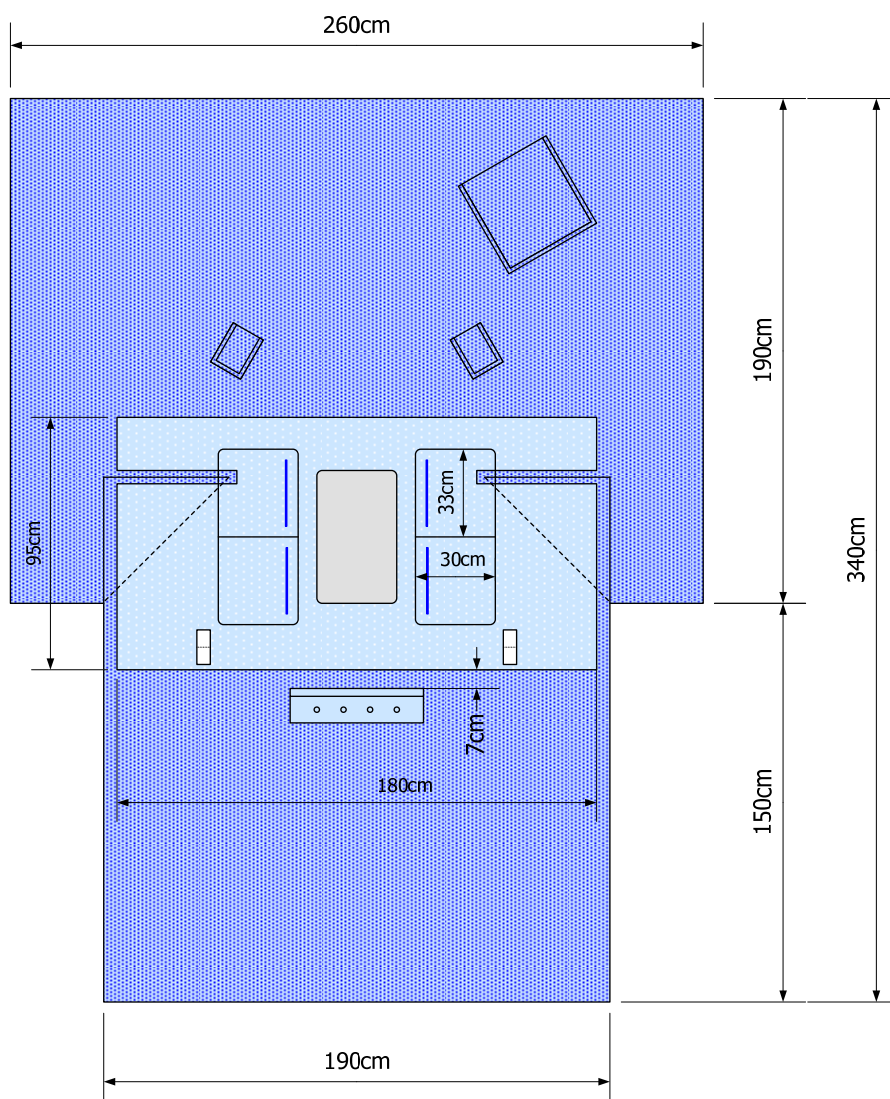

● 3-laags 60 gsm
 ● ondoordringbaar Ultra-Absorberend
 ● Incisie film

Materiaal	Afmeting	Component nummer	Bestel nummer	Aantal per doos	Bestel nummer	Aantal per doos
			steriel		steriel	
			Standaard verpakking		Eco verpakking	
3-laags	340 x 190/260 cm	1307399	105761AA			
4 zakken						
3 instrument zakken						
Armsteun bedekkingen						
Venster 50 x 30 cm met volledige Incisie tape						

8 Angiografie

8.1 Femoraal Angio lakens

8.1.1 Femoraal Angio laken, volledig transparant rechts

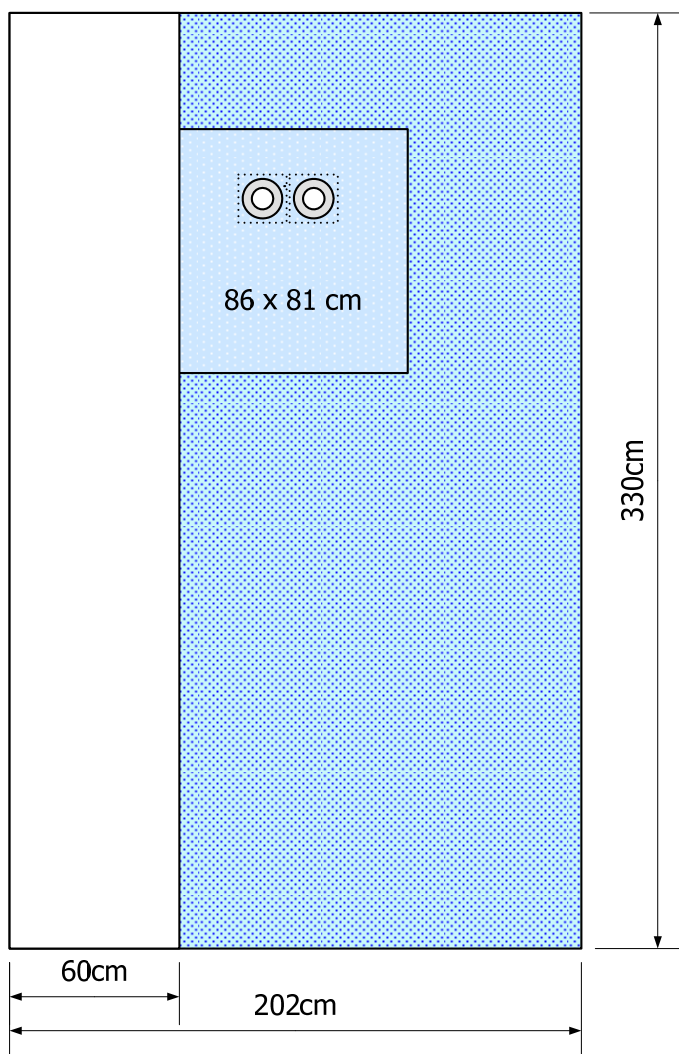

Prestico®
 Ondoordringbaar Ultra-Absorberend
 Transparante film
 Incisie film

Materiaal	Afmeting	Component nummer	Bestel nummer steriel	Aantal per doos	Bestel nummer steriel	Aantal per doos
Prestico®	330 x 202 cm	1302487	106193AA	Standaard verpakking	Eco verpakking	

Vensters Ø 14 cm

Incisie film met venster van Ø 7,5 cm

8.1.2 Femoraal Angio laken Ultra absorberend, volledig Transparant rechts en links

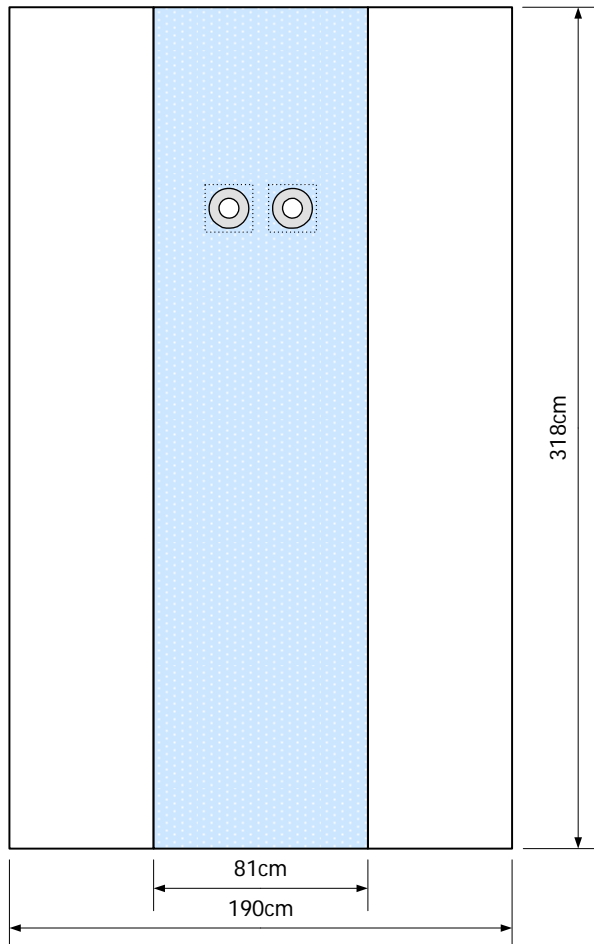

Ondoordringbaar Ultra-Absorberend
 Transparante film
 Incisie film

Materiaal	Afmeting	Component nummer	Bestel nummer steriel	Aantal per doos	Bestel nummer steriel	Aantal per doos
HC-Pad	318 x 190 cm	1301263	103648AA	10		
			Standaard verpakking		Eco verpakking	
Vensters Ø 15 cm						
Incisie film met venster van Ø 7,5 cm						

8.1.3 Femoraal Angio laken Ultra absorberend, volledig Transparant rechts en links XL

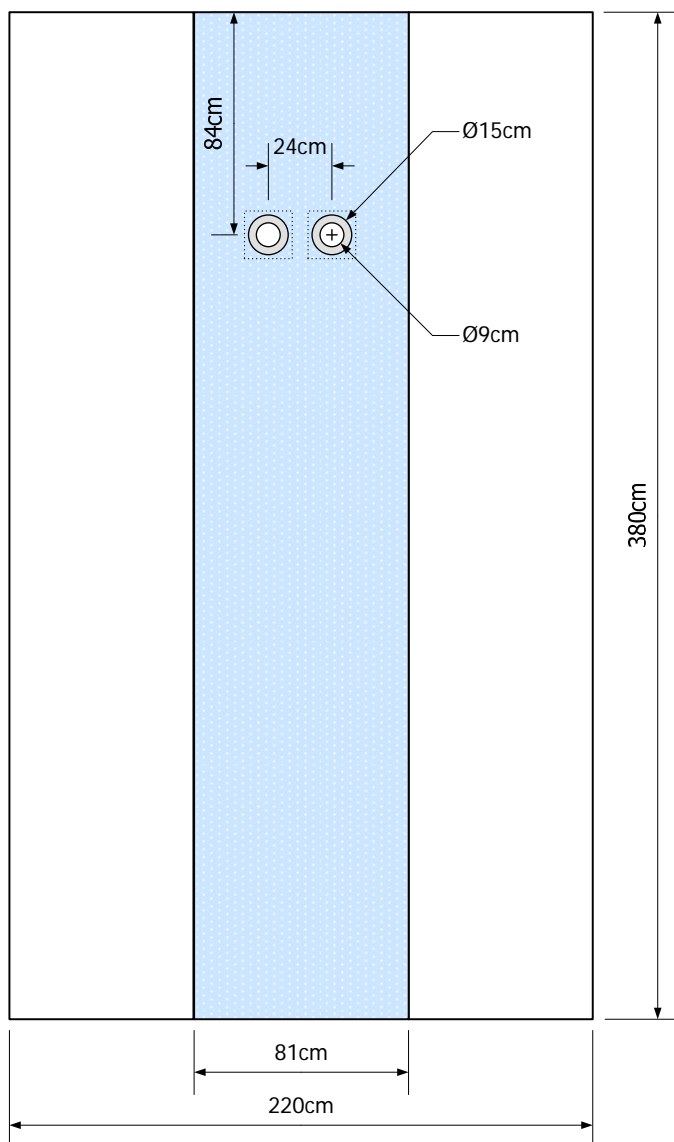

Ondoordringbaar Ultra-Absorberend
 Transparant film
 Incisie film

Materiaal	Afmeting	Component nummer	Bestel nummer steriel	Aantal per doos	Bestel nummer steriel	Aantal per doos
HC-Pad	380 x 220 cm	1301564	103670AA	8		
			Standaard verpakking		Eco verpakking	

Vensters Ø 15 cm

Incisie film met Venster van Ø 9 cm

8.1.4 Femoraal Angio laken Ultra absorberend, volledig Transparant rechts en links XW

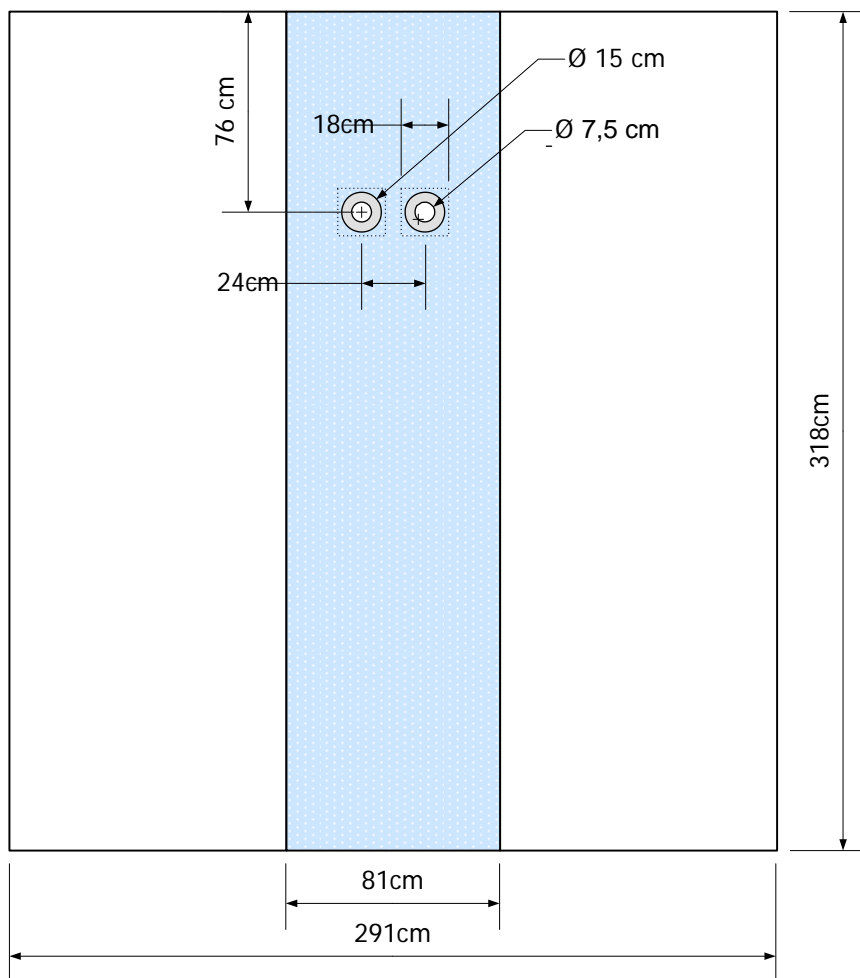

Ondoordringbaar Ultra-Absorberend
 Transparant film
 Incisie film

Materiaal	Afmeting	Component nummer	Bestel nummer steriel	Aantal per doos	Bestel nummer steriel	Aantal per doos
HC-Pad	318 x 291 cm	1301547	103671AA	10		

Vensters Ø 15 cm

Incisie film met Venster van Ø 7,5 cm

8.1.5 Femoraal Angio laken, Ultra Absorberend, volledig Transparant 3-sides

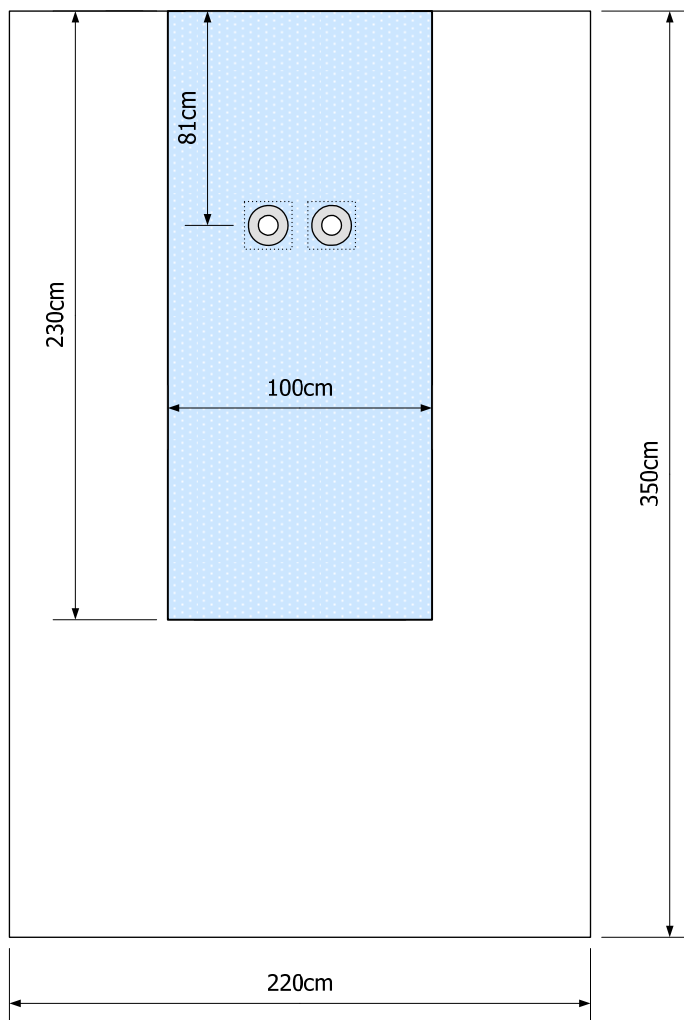

Transparant film
 Ondoordringbaar Ultra-Absorberend
 Incisie film

Materiaal	Afmeting	Component nummer	Bestel nummer steriel	Aantal per doos	Bestel nummer steriel	Aantal per doos
HC-Pad	350 x 220 cm	1301560	103501AA	10	Standaard verpakking	Eco verpakking

Vensters Ø 15 cm

Incisie film met Venster van Ø 7,5 cm

8.1.6 Femoraal Paediatric Angiography laken

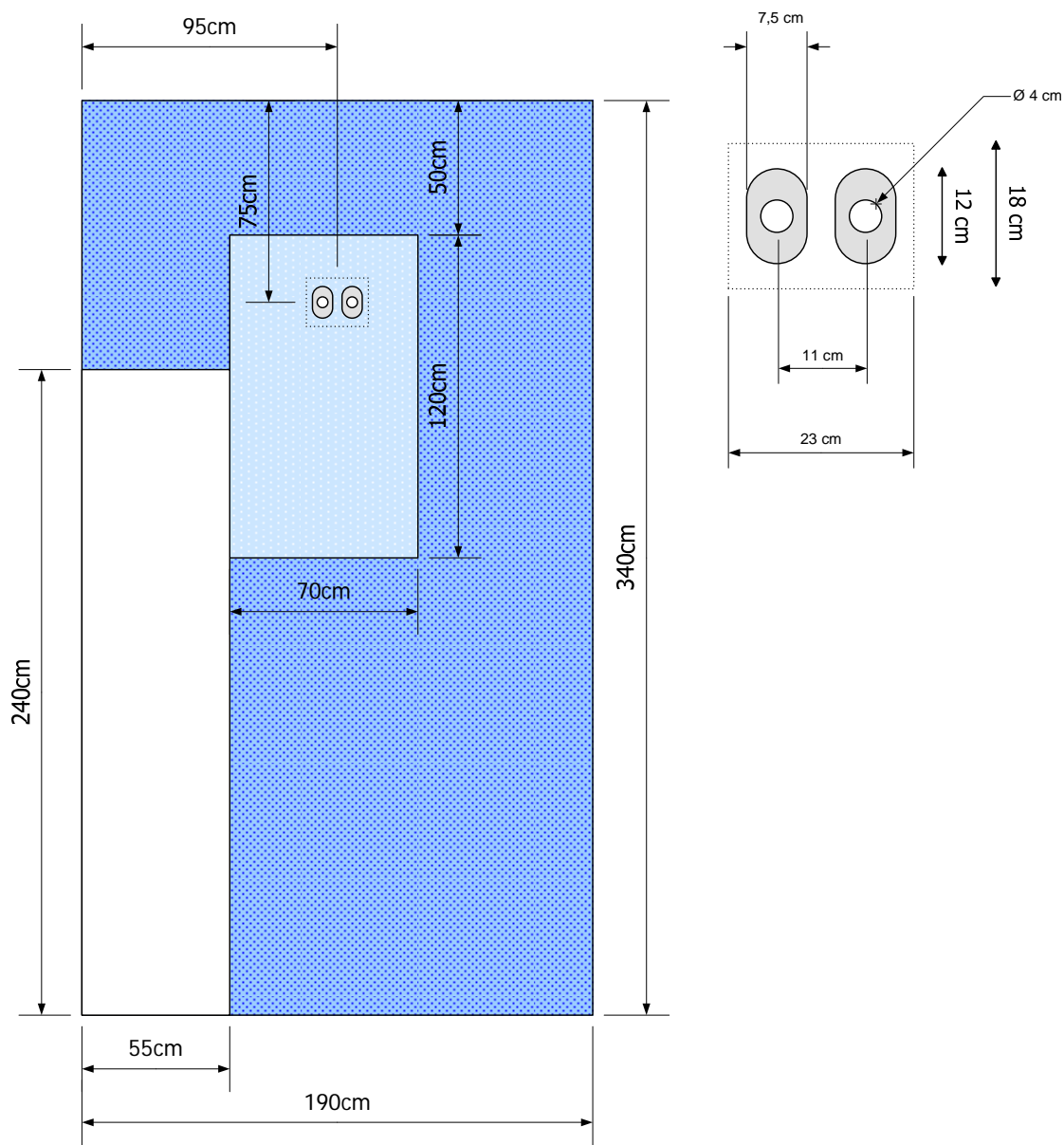

● 3-laags
 ○ Transparant film
 ● Ondoordringbaar Ultra-Absorberend
 ○ Incisie film

Materiaal	Afmeting	Component nummer	Bestel nummer steriel	Aantal per doos	Bestel nummer steriel	Aantal per doos
3-laags	340 x 190 cm	1302095	104552AA	10		
			Standaard verpakking		Eco verpakking	
Vensters Ovaal 7,5 x 12 cm						
Incisie film met Venster van Ø 4 cm						

8.2 Femoraal Radial Angio lakens

8.2.1 Femoraal Radial Angiografie laken, standaard

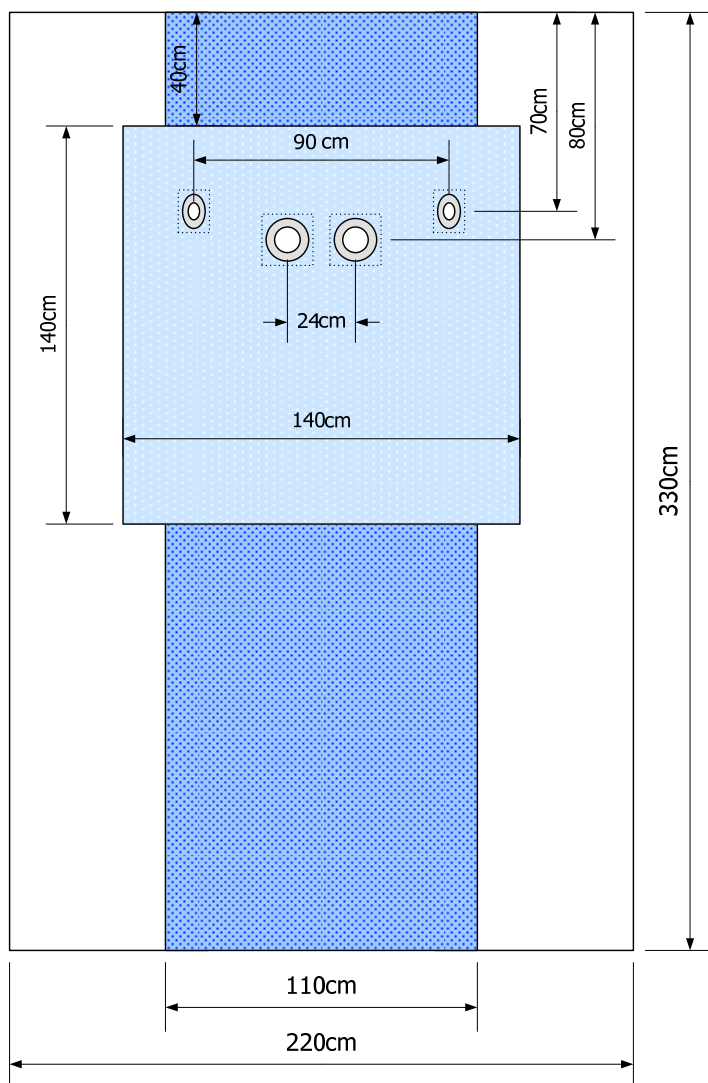

● 3-laags
 Transparant film
 Ondoordringbaar Ultra-Absorberend
 Incisie film

Materiaal	Afmeting	Component nummer	Bestel nummer steriel	Aantal per doos	Bestel nummer steriel	Aantal per doos
			Standaard verpakking		Eco verpakking	
3-laags	330 x 220 cm	1301908	104553AA	10		

Femorale vensters: Incisie film Ø 15 cm met Venster van Ø 9 cm

Radiale vensters: Incisie film ovaal 12 x 8 cm met ovaal Venster van 6 x 4 cm

8.2.2 Femoraal Radial Angiography laken, XL

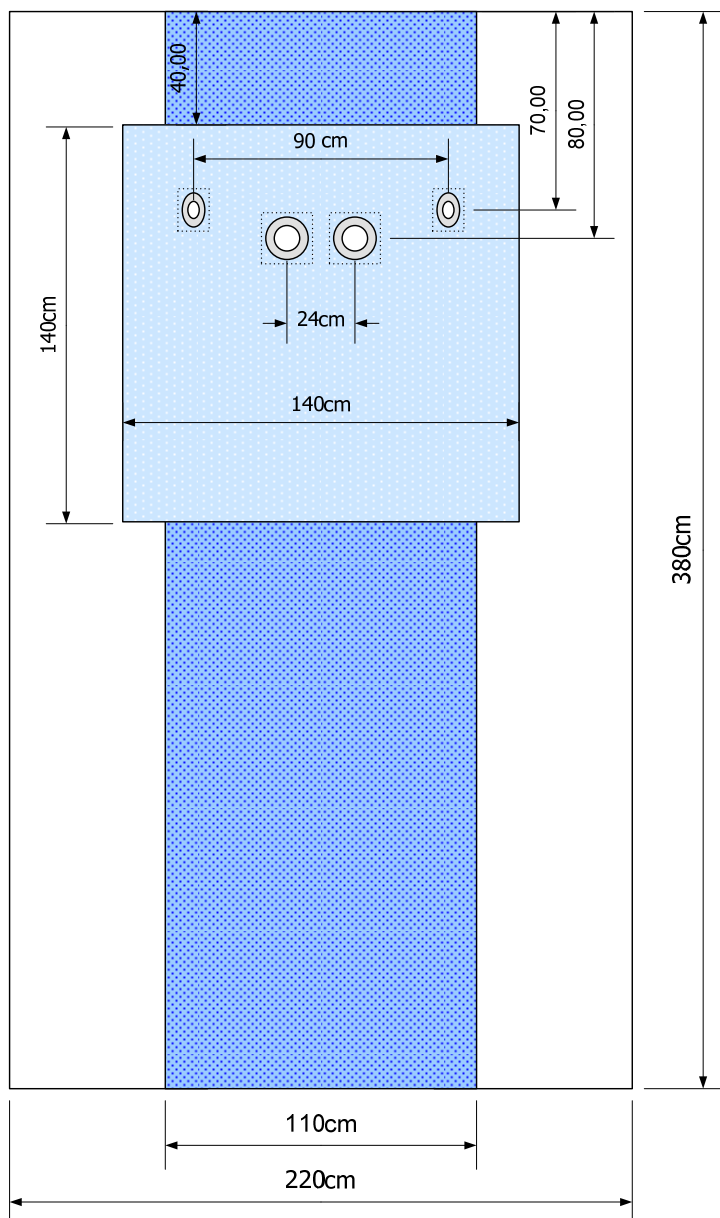

● 3-laags
 Transparant film
 Ondoordringbaar Ultra-Absorberend
 Incisie film

Materiaal	Afmeting	Component nummer	Bestel nummer steriel	Aantal per doos	Bestel nummer steriel	Aantal per doos
3-laags	380 x 220 cm	1301907	104541AA	8	Standaard verpakking	Eco verpakking

Femorale vensters: Incisie film Ø 15 cm met Venster van Ø 9 cm

Radiale vensters: Incisie film ovaal 12 x 8 cm met ovaal Venster van 6 x 4 cm

9 Pacemaker lakens

9.1 Pacemaker laken met Venster

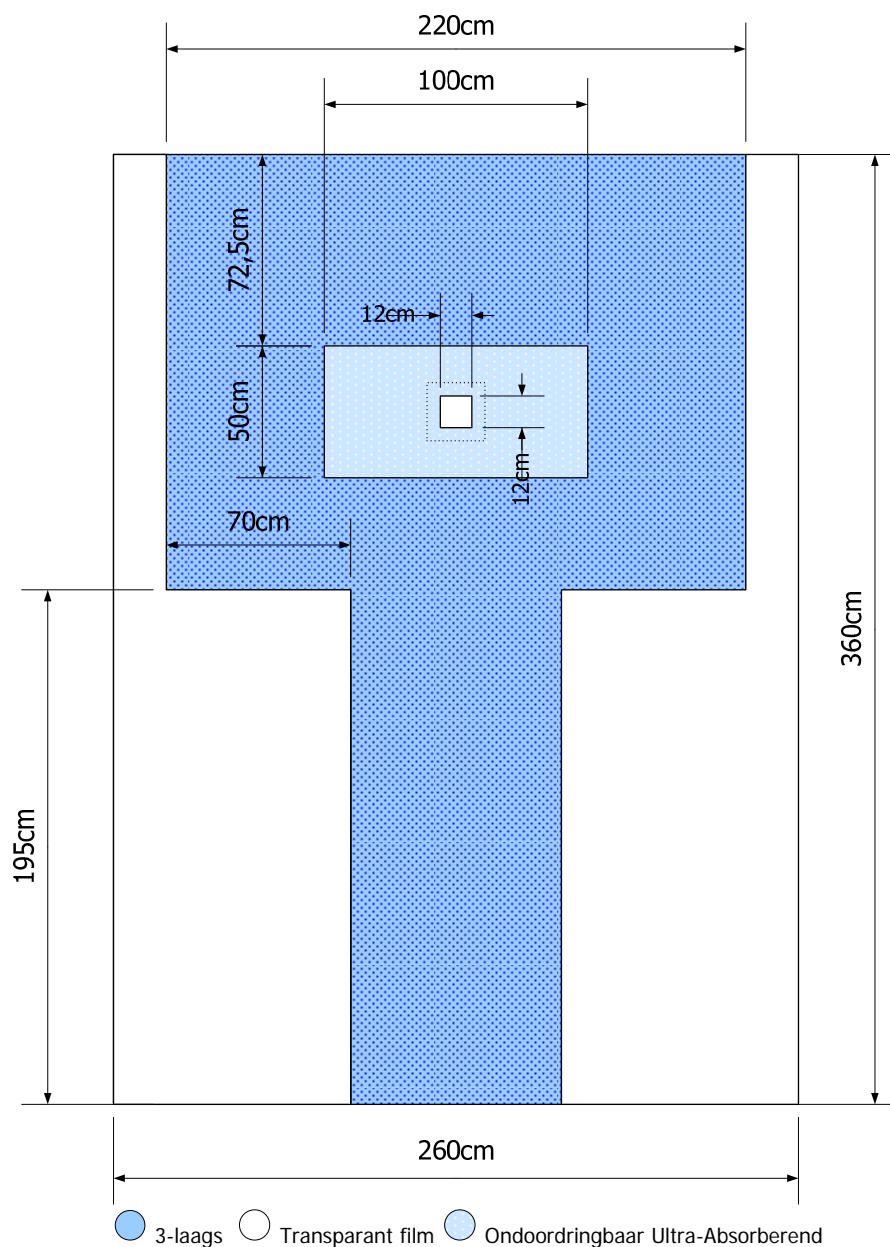

Materiaal	Afmeting	Component nummer	Bestel nummer steriel	Aantal per doos	Bestel nummer steriel	Aantal per doos
			Standaard verpakking		Eco verpakking	
3-laags	360x260 cm	1301983	104542AA	5		

9.2 Pacemaker laken met Venster en Incisie tape

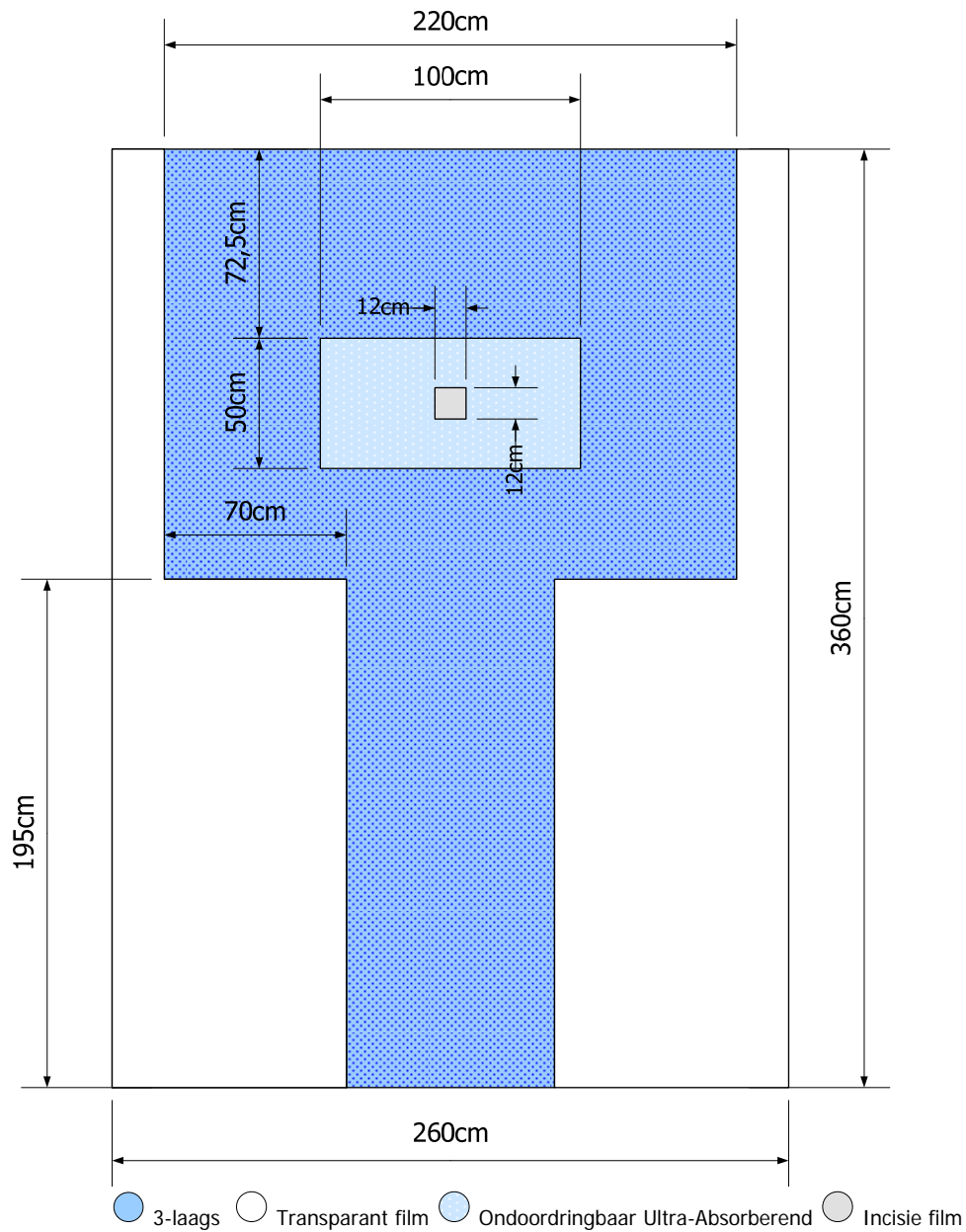

Materiaal	Afmeting	Component nummer	Bestel nummer steriel	Aantal per doos	Bestel nummer steriel	Aantal per doos
3-laags	360x260 cm	1302672	Standaard verpakking		Eco verpakking	

9.3 Pacemaker tunnel laken

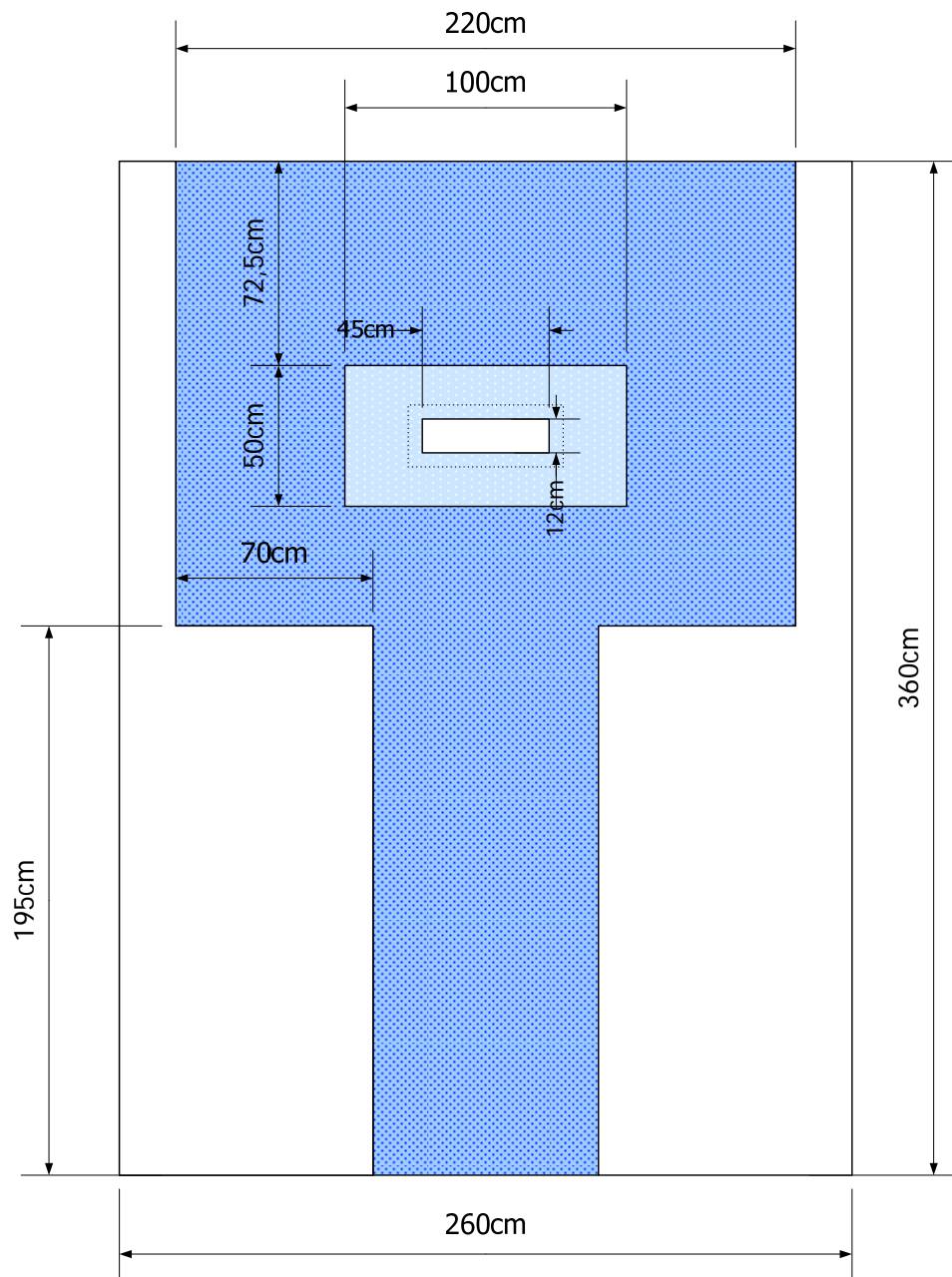

● 3-laags
 ○ Transparant film
 ○ Ondoordringbaar Ultra-Absorberend

Materiaal	Afmeting	Component nummer	Bestel nummer steriel	Aantal per doos	Bestel nummer steriel	Aantal per doos
			Standaard verpakking		Eco verpakking	
3-laags	360 x 260cm	1302209	104543AA			

10 Accessoires

10.1 Tape strip

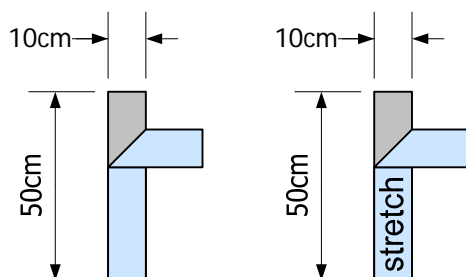

Materiaal	Afmeting	Component nummer	Bestel nummer steriel	Aantal per doos	Bestel nummer steriel	
					Standaard verpakking	Eco verpakking
Standaard	10 x 50 cm	1302102	22T788C	200		
Stretch	10 x 50 cm	1302104	22T790A	200		
Standaard	10 x 50 cm	1301916	22T789A	200	11063EG	4x250

10.2 Mouwtje

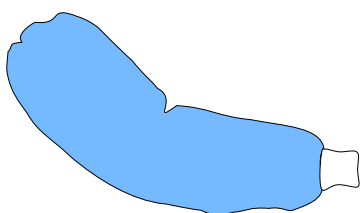

● 2-layers materiaal

Materiaal	Afmeting	Component nummer	Bestel nummer steriel	Aantal per doos	Bestel nummer steriel	
					Standaard verpakking	Eco verpakking
2-laags	46 cm	1306944	103680AA	2x50		
2-laags	46 cm	1302240			11070EG	2x30

10.3 Armsteun hoes en stoelhoes

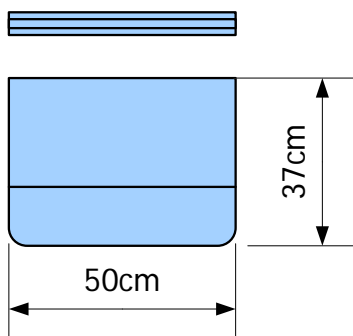

● Airlaid/Wetlaid

Materiaal	Afmeting	Component nummer	Bestel nummer steriel	Aantal per doos	Bestel nummer steriel	Aantal per doos
					Standaard verpakking	Eco verpakking
Airlaid/Wetlaid	37 x 50 cm	1301343	103508AA	100		

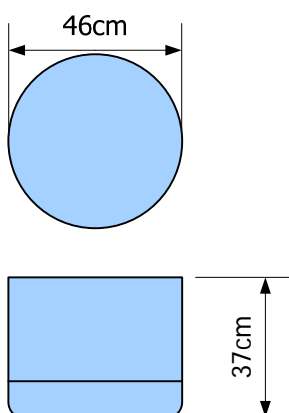

● Airlaid/Wetlaid

Materiaal	Afmeting	Component nummer	Bestel nummer steriel	Aantal per doos	Bestel nummer steriel	Aantal per doos
					Standaard verpakking	Eco verpakking
Airlaid/Wetlaid	37 x 46 cm	1301341	103509AA	2x50		
2-laags	37 x 46 cm	1302241	106255AA		11071EG	2x25

10.4 Stockinettes

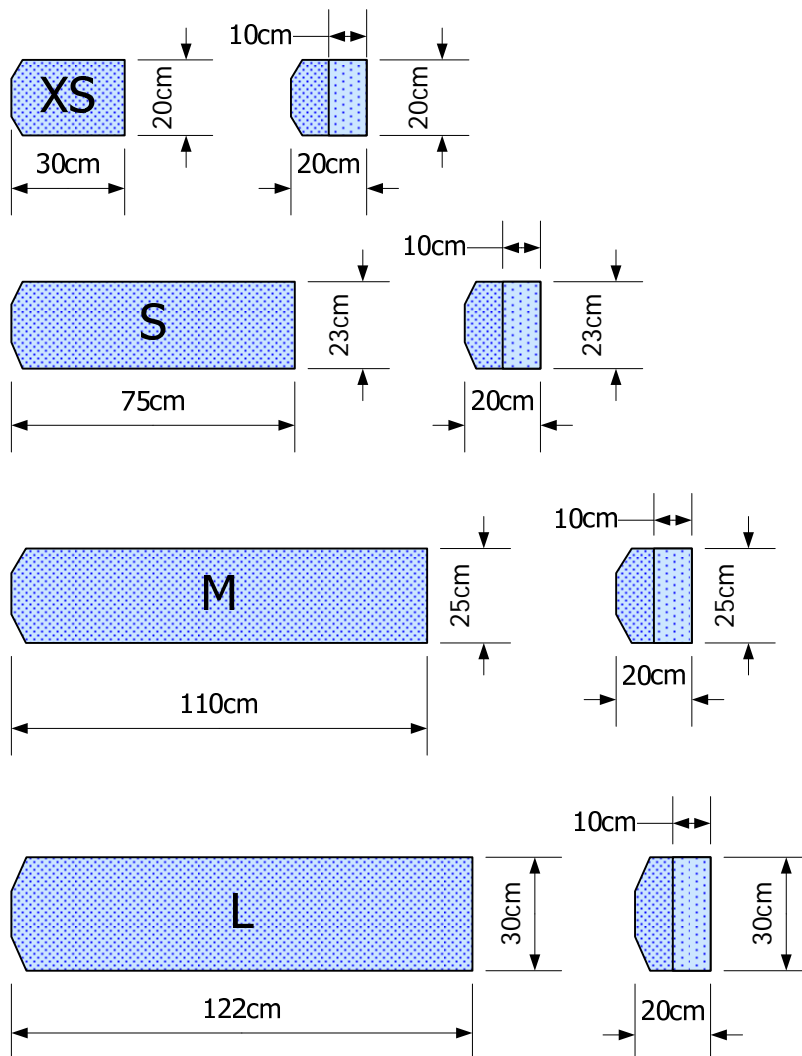

 2-layers materiaal

Materiaal	Afmeting	Component nummer	Bestel nummer steriel	Aantal per doos	Bestel nummer steriel	Aantal per doos
				Standaard verpakking		Eco verpakking
2-laags	30 x 20 cm (XS)	1307242	104544AA			
2-laags	72 x 23 cm (S)	1301491	104545AA			
2-laags	110 x 25 cm (M)	1307243	104546AA			
2-laags	122 x 30 cm (L)	1301513	104547AA			
Telescoop gevouwen						

10.5 Stockinettes eco verpakking

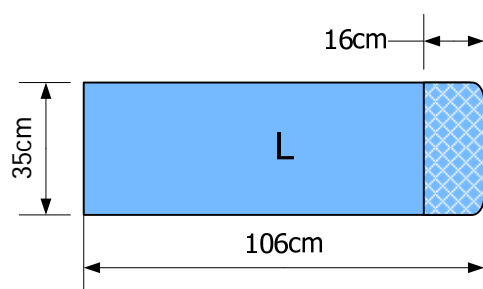
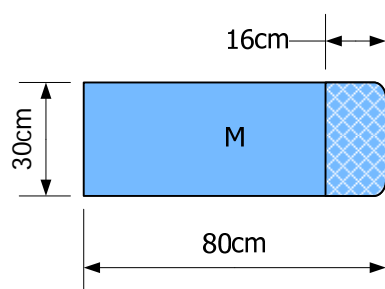
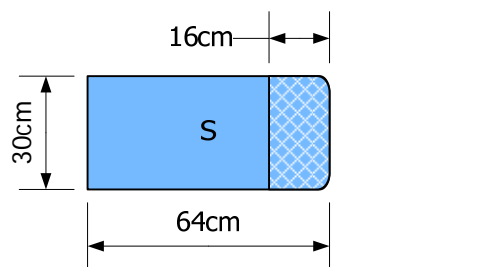

● 2-laags

Materiaal	Afmeting	Component nummer	Bestel nummer steriel	Aantal per doos	Bestel nummer steriel	Aantal per doos
				Standaard verpakking		Eco verpakking
2-laags	30 x 80 cm (S)	1302238	106256AA		11067EG	2 x 75
2-laags	30 x 122 cm (M)	1301930	106257AA		11068EG	2 x 70
2-laags	35 x 122 cm (L)	1301922	106258AA		11069EG	2 x 60

Telescoepe gevouwen

10.6 Roll Stockinettes

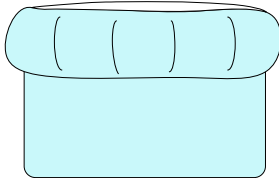

 Elastisch materiaal

Materiaal	Afmeting	Component nummer	Bestel nummer	Aantal per doos	Bestel nummer	Aantal per doos
			steriel		steriel	
			Standaard verpakking		Eco verpakking	
Elastisch	70 x 22 cm (L)	1307379	105763AA			
Elastisch	122 x 30 cm (XL)	1307380	105764AA			
Non woven voering						

10.7 Beenhoezen

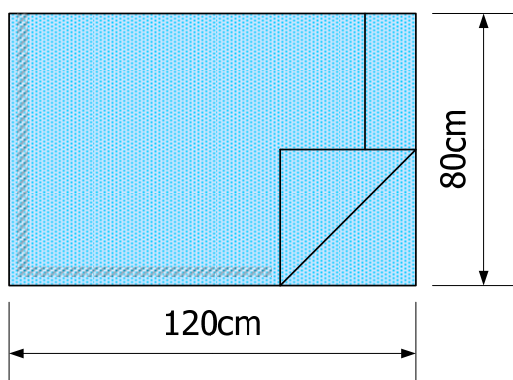

SMS

Materiaal	Afmeting	Component nummer	Bestel nummer steriel	Aantal per doos	Bestel nummer steriel	Aantal per doos
				Standaard verpakking		Eco verpakking
SMS	80 x 120 cm	1301925	106259AA		11066EG	35x2 (70 units)
SMS	80 x 120 cm	1301925 x2	106260AA		11092EG	17x2 (34 pairs)

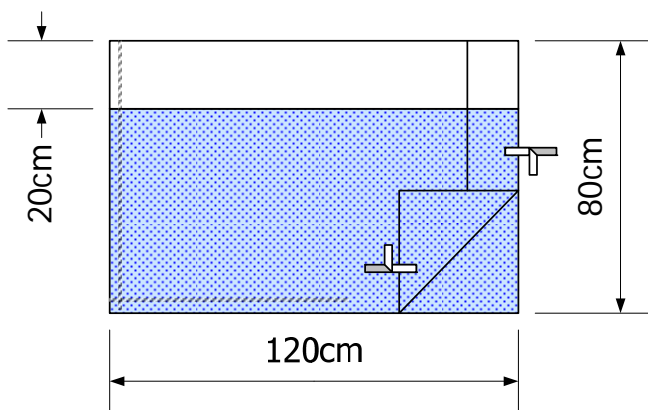

2-laags Transparant PE Film

Materiaal	Afmeting	Component nummer	Bestel nummer steriel	Aantal per doos	Bestel nummer steriel	Aantal per doos
				Standaard verpakking		Eco verpakking
2-laags	80 x 120 cm	1302184	104548AA			

10.8 Diathermie zakken

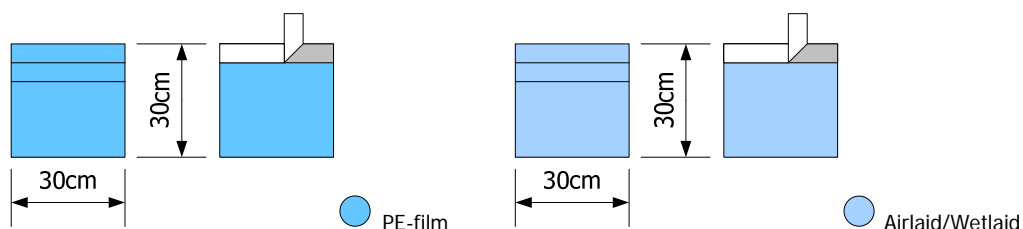

Materiaal	Afmeting	Component nummer	Bestel nummer steriel	Aantal per doos	Bestel nummer steriel	Aantal per doos
					Standaard verpakking	Eco verpakking
PE Film	30 x 30cm	1302084	103513AA	100		
Airlaid/Wetlaid	30 x 30cm	1302183	103546AA	30		

tape 5 cm breed

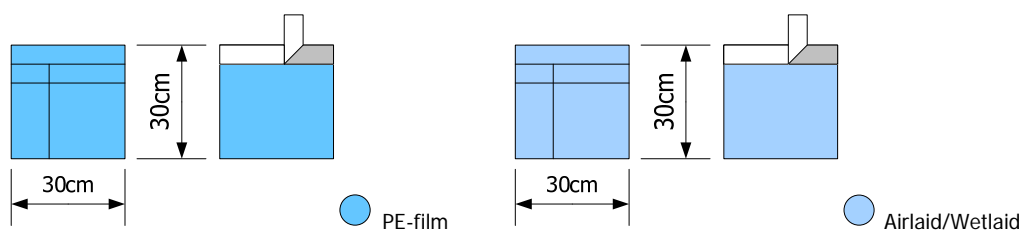

Materiaal	Afmeting	Component nummer	Bestel nummer steriel	Aantal per doos	Bestel nummer steriel	Aantal per doos
					Standaard verpakking	Eco verpakking
PE Film	30 x 30cm	1302080	103664AA	100		
Airlaid/Wetlaid		1302185	103547AA	30		

2 vakken, 9 cm en 19 cm breed, tape 5 cm breed

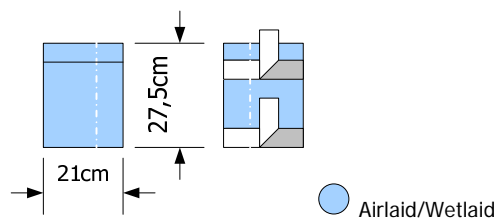

Materiaal	Afmeting	Component nummer	Bestel nummer steriel	Aantal per doos	Bestel nummer steriel	Aantal per doos
					Standaard verpakking	Eco verpakking
Airlaid/Wetlaid	27,5 x 21cm	1302078	103665AA	100		

2 vakken, 14 cm en 7 cm breed, 2x tape at the backside 5 cm breed

10.9 Handdoekje

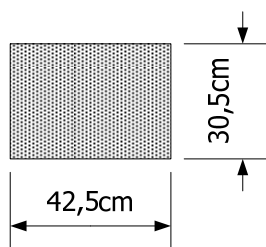

 Paper

Materiaal	Afmeting	Component nummer	Bestel nummer steriel	Aantal per doos	Bestel nummer steriel	
					Standaard verpakking	Eco verpakking
Paper	30,5 x 42,5 cm	1306929	103666AA	200		
Paper	34 x 61 cm	1307245	106261AA		11064EG	

10.10 Baby Handdoekje

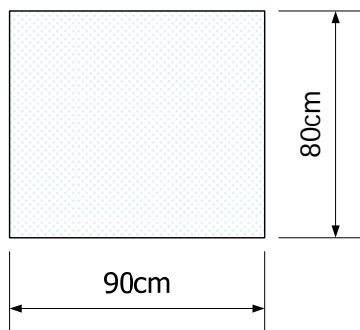

Materiaal	Afmeting	Component nummer	Bestel nummer steriel	Aantal per doos	Bestel nummer steriel	
					Standaard verpakking	Eco verpakking
Spunlace	80 x 90 cm	1301935	106262AA		11065EG	2x50

10.11 Perineal laken

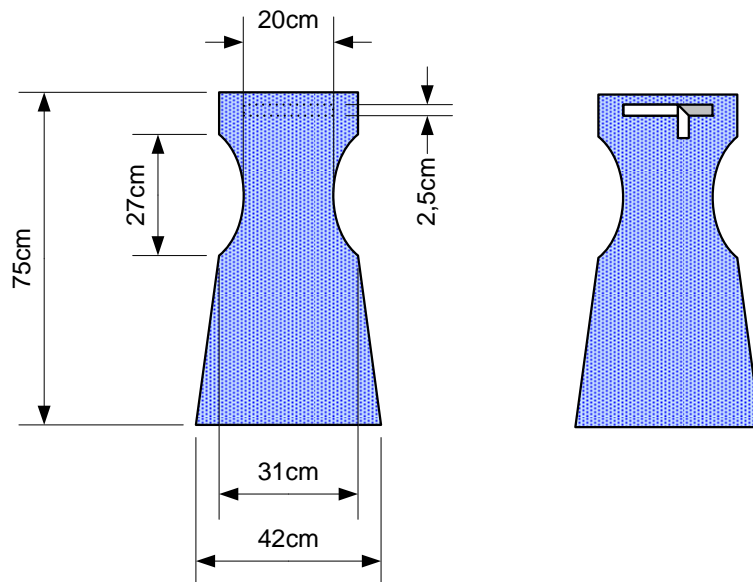

● 3-laags

Materiaal	Afmeting	Component nummer	Bestel nummer	Aantal per doos	Bestel nummer	Aantal per doos
			steriel		steriel	
			Standaard verpakking		Eco verpakking	
3-laags	75 x 42 cm	1307299	104549AA	60		

11 Code index component

Nummer	Pagina	Nummer	Pagina	Nummer	Pagina
1301114	47	1301921	40,55,58,59	1302228	40
1301238	51	1301922	55,125	1302229	43
1301263	112	1301923	53,79	1302230	43
1301336	42	1301924	54,79	1302231	49
1301341	123	1301925	79,127	1302232	49
1301342	107	1301926	57,74	1302233	49
1301343	123	1301927	41	1302234	64
1301441	48	1301928	58,60,86	1302235	98
1301443	44	1301929	59,69	1302236	99
1301446	44	1301930	59,125	1302238	125
1301491	124	1301931	53,78	1302240	122
1301513	56,124	1301932	80,82	1302241	123
1301539	47	1301933	45,80	1302275	73
1301547	114	1301934	81,90	1302292	77
1301560	115	1301935	81,129	1302311	26
1301564	113	1301956	12	1302322	23
1301578	52	1301958	37	1302323	20,28
1301673	15	1301961	106	1302324	32
1301676	15	1301963	109	1302376	10
1301690	8	1301975	42	1302383	16,25
1301691	8	1301977	62	1302399	96
1301725	101	1301980	24,103	1302425	107
1301741	9	1301982	27,103	1302462	18,20,21,56
1301742	9	1301983	119	1302463	26
1301829	6	1302022	36	1302464	41
1301830	6	1302064	63	1302465	61
1301853	42	1302078	128	1302466	75
1301873	6	1302080	128	1302467	41
1301874	6	1302081	13	1302468	22
1301875	6	1302083	13	1302469	29,56
1301876	6	1302084	128	1302470	41
1301877	6	1302085	14	1302471	83
1301878	6	1302095	116	1302472	18,24
1301879	6	1302102	18,20,56,122	1302473	91
1301880	16,21,55	1302104	122	1302474	41
1301881	16,24	1302114	14	1302475	34
1301901	16,17,18,19,20, 38,55,56,57,58, 59,78,80,81,103	1302127	85	1302476	92
1301902	38	1302128	86	1302477	102
1301904	100	1302168	21	1302479	41
1301907	118	1302169	24	1302480	104
1301908	117	1302182	88	1302481	35
1301914	13	1302183	128	1302482	105
1301915	13	1302184	127	1302483	108
1301916	16,17,19,55,57, 58,59,80,103,122	1302185	128	1302484	97
1301917	19	1302209	121	1302485	50
1301918	19,25	1302219	5	1302486	108
1301919	19,45	1302220	5	1302487	111
1301920	28,55	1302221	5	1302488	41
		1302225	5	1302489	65
		1302226	5	1302502	5
		1302227	40	1302503	5

11 Code index component

Nummer	Pagina	Nummer	Pagina	Nummer	Pagina
1302504	46	1306755	16,17,18,19,20, 37,55,56,57,58, 59,78,79,80,81, 103	1307253	28
1302505	39	1306756	37	1307255	17,21
1302506	39	1306757	37	1307256	17,25
1302507	39	1306758	37	1307266	89
1302541	98	1306759	37	1307267	30
1302542	67	1306760	38	1307297	11
1302544	70	1306929	18,115	1307298	11
1302545	66	1306944	121	1307299	130
1302556	26	1306954	33,56	1307335	7
1302563	93	1306997	68	1307336	7
1302566	95	1307070	6	1307337	7
1302567	99	1307071	6	1307338	7
1302639	94	1307072	6	1307339	7
1302640	72	1307074	18, 25	1307340	7
1302641	76	1307076	6	1307341	7
1302642	10	1307077	6	1307342	7
1302672	120	1307078	6	1307343	7
1304055	48	1307082	6	1307344	7
1304088	42	1307083	6	1307345	7
1304099	42	1307084	6	1307346	7
1304103	44	1307138	23	1307378	84
1306745	5	1307156	71	1307379	126
1306746	5	1307176	23	1307380	126
1306748	5	1307211	31	1307381	48
1306749	5	1307242	124	1307383	87
1306750	5	1307243	124	1307399	110
1306754	33	1307245	16,17,19,55,57, 58,59,78,79,80, 81,103,129	1309403	47
				1309415	44
				1309428	44
				1309495	42
				1309572	42

12 Code index component beschermende kleding niet steriel

Nummer	Pagina
06536	15
06537	15
06541	8
06542	8
06580	12
06581	13
06582	13
06583	14
10155	14
52557	13
52558	13
104200AA	11
104201AA	11

13 Product code index ordernummers steriel

Nummer	Pagina	Nummer	Pagina	Nummer	Pagina	Nummer	Pagina
77000	44	2543070	5	104539AA	100	106191AA	40
77001	42	103466AA	33	104540AA	101	106193AA	111
77002	47	103470AA	42	104541AA	118	106194AA	108
77003	47	103472AA	48	104542AA	119	106195AA	108
77004	42	103473AA	48	104543AA	121	106201AA	40
94000	48	103474AA	47	104544AA	124	106202AA	41
2540530	5	103477AA	51	104545AA	124	106203AA	41
2540540	5	103484AA	68	104546AA	124	106204AA	41
2540570	5	103495AA	107	104547AA	124	106205AA	41
2540600	5	103501AA	115	104548AA	127	106206AA	41
2540610	6	103508AA	123	104549AA	130	106207AA	41
2540620	6	103509AA	123	104550AA	37	106212AA	43
2540630	6	103513AA	128	104552AA	116	106213AA	43
2540650	6	103546AA	128	104553AA	117	106214AA	45
0540670	6	103547AA	128	104556AA	63	106215AA	45
2540680	6	103621AA	37	105003AA	24	106222AA	49
2540690	6	103622AA	37	105020AA	28	106223AA	50
2570700	6	103623AA	37	105021AA	23	106224AA	53
2541940	5	103624AA	37	105066AA	77	106225AA	54
2541950	6	103635AA	37	105113AA	21	106226AA	56
2542080	6	103636AA	37	105260AA	21	106227AA	60
2542090	6	103640AA	25	105683AA	24	106228AA	61
2542100	6	103647AA	107	105761AA	110	106229AA	64
2542110	6	103648AA	112	105762AA	73	106232AA	65
2542120	6	103664AA	128	105763AA	126	106234AA	66
2542130	6	103665AA	128	105764AA	126	106236AA	74
2542140	6	103666AA	129	106016AA	26	106238AA	75
2542150	6	103670AA	113	106105AA	34	106239AA	82
2542160	6	103671AA	114	106168AA	67	106240AA	83
2542340	9	103680AA	122	106171AA	18	106241AA	90
2542350	9	103682AA	44	106172AA	20	106242AA	91
2542530	5	103694AA	38	106173AA	21	106243AA	92
2542540	5	103697AA	62	106174AA	21	106244AA	95
2542550	5	103698AA	109	106175AA	22	106246AA	96
2542560	7	103847AA	106	106176AA	23	106247AA	97
2542570	7	103848AA	38	106177AA	23	106248AA	98
2542580	7	103849AA	38	106178AA	24	106250AA	99
2542590	7	103853AA	99	106179AA	24	106251AA	102
2542600	7	104030AA	30	106180AA	25	106252AA	104
2542610	7	104362AA	69	106181AA	25	106253AA	105
2542650	7	104529AA	42	106182AA	25	106255AA	123
2542660	7	104530AA	42	106183AA	26	106256AA	125
2542670	7	104531AA	42	106184AA	27	106257AA	125
2542680	7	104532AA	42	106185AA	28	106258AA	125
2542690	7	104533AA	44	106186AA	29	106259AA	127
2542700	7	104534AA	44	106187AA	32	106260AA	127
2542710	5	104535AA	52	106188AA	35	106261AA	129
2542720	5	104537AA	85	106189AA	40	106262AA	129
2543020	5	104538AA	86	106190AA	40	106263AA	49

13 Product code index ordernummers sterile

Nummer	Pagin a	Nummer	Pagin a	Nummer	Pagin a	Nummer	Pagin a
106264AA	49	11033EG	24	11064EG	129	11101EG	7
106265AA	53	11036EG	25	11065EG	129	11102EG	7
106274AA	98	11037EG	28	11066EG	127	11103EG	7
11000EG	16	11038EG	28	11067EG	125	11104EG	7
11001EG	19	11039EG	40	11068EG	125	11105EG	7
11002EG	55	11040EG	40	11069EG	125	11106EG	7
11003EG	79	11041EG	40	11070EG	122	11107EG	7
11004EG	57	11042EG	40	11071EG	123	11108EG	7
11005EG	58	11044EG	45	11073EG	6	11109EG	7
11006EG	59	11045EG	43	11074EG	6	11110EG	7
11007EG	78	11046EG	43	11075EG	6	11111EG	7
11008EG	80	11047EG	49	11076EG	6	11140EG	5
11009EG	81	11048EG	49	11077EG	6	11141EG	5
11010EG	103	11049EG	49	11078EG	6	11142EG	21
11011EG	5	11050EG	53	11079EG	6	11143EG	25
11012EG	17	11051EG	53	11080EG	6	11144EG	37
11013EG	5	11052EG	37	11082EG	6	22T789C	122
11014EG	5	11053EG	38	11083EG	6	22T789A	122
11015EG	5	11054EG	74	11084EG	6	22T790A	122
11016EG	5	11055EG	60	11085EG	6		
11017EG	5	11056EG	69	11086EG	6		
11024EG	5	11057EG	64	11087EG	6		
11026EG	5	11058EG	53	11088EG	6		
11027EG	5	11059EG	82	11089EG	6		
11028EG	5	11060EG	90	11090EG	6		
11029EG	21	11061EG	98	11091EG	6		
11031EG	24	11062EG	99	11092EG	127		
11032EG	45	11063EG	122	11100EG	7		